

EVALUATION KIT  
AVAILABLE

# MAXIM

## Stereo Audio DAC with DirectDrive Headphone Amplifier

MAX9850

### General Description

The MAX9850 is a low-power, high-performance stereo audio DAC with an integrated DirectDrive™ headphone amplifier. The MAX9850 is designed to meet the board space and performance requirements of portable devices such as cell phones and MP3 and portable DVD players.

The MAX9850 uses Maxim's patented† DirectDrive headphone technology that produces a ground-biased analog audio output from a single supply, which allows for driving the headphones directly from the amplifier outputs without large DC-blocking capacitors. This feature saves board space, provides higher click/pop suppression, and improves low-frequency (bass) response. The architecture does not require the headphone jack to be biased to a DC voltage and thus allows for a conventional, grounded chassis design.

The MAX9850's flexible clocking circuitry utilizes any available system clock up to 40MHz, eliminating the need for an external PLL and multiple crystal oscillators. The DAC supports a wide range of sample rates from 8kHz to 48kHz in both master and slave modes, making the MAX9850 the easiest to use and most versatile audio DAC available. It can also be operated like traditional synchronous DACs, at any integer-oversampling ratio.

The audio DAC receives input data over a flexible 3-wire interface that supports left-justified, right-justified audio data, or I<sup>2</sup>S-compatible audio data. Stereo audio line inputs are provided to either mix analog audio with the digital input stream, or to drive the headphone outputs directly. Mode settings, headphone amplifier volume controls, and shutdown for both the headphone and line outputs are programmed through a 2-wire, I<sup>2</sup>C-compatible interface.

The MAX9850 is fully specified over the -40°C to +85°C extended temperature range and is available in a low-profile, 28-pin thin QFN package (5mm x 5mm x 0.8mm).

### Applications

MP3/Portable Multimedia Players  
Cell Phones/Smart Phones  
Portable DVD Players

†U.S. Patent #7,061,327

### Features

- ◆ 1.8V to 3.6V Single-Supply Operation
- ◆ 30mW Stereo Headphone Output Power with 1.8V Supply
- ◆ DirectDrive Outputs Eliminate DC-Blocking Capacitors
- ◆ 91dB PSRR at 1kHz
- ◆ Any Master Clock Up to 40MHz
- ◆ Flexible I<sup>2</sup>S-Compatible Digital Audio Interface
- ◆ I<sup>2</sup>C Headphone Volume and Mute Control
- ◆ Stereo Line Inputs and Outputs
- ◆ Clickless/Popless Operation
- ◆ 2-Wire (I<sup>2</sup>C)-Compatible Control Interface
- ◆ Available in 28-Pin Thin QFN Package

### Ordering Information

PART	TEMP RANGE	PIN-PACKAGE	PKG CODE
MAX9850ETI+	-40°C to +85°C	28 TQFN-EP**	T2855-6

\*\*EP = Exposed pad.

+Denotes lead-free package.

Pin Configuration appears at end of data sheet.

### Block Diagram

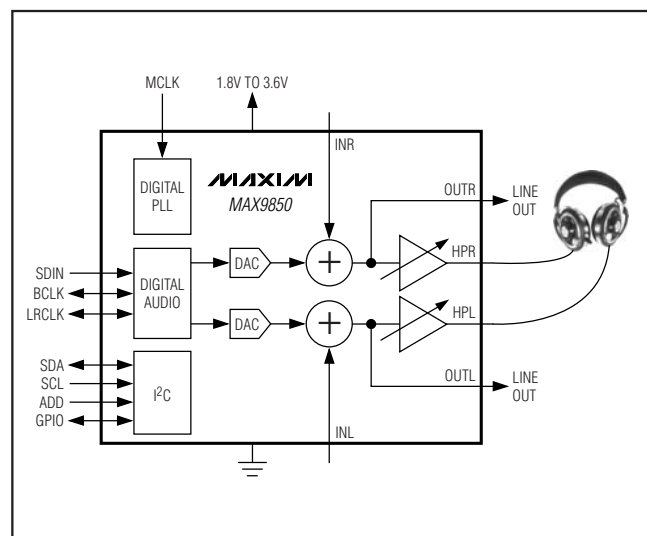

# Stereo Audio DAC with DirectDrive Headphone Amplifier

## ABSOLUTE MAXIMUM RATINGS

(Voltages with respect to AGND.)

DV <sub>DD</sub> , AV <sub>DD</sub> , PV <sub>DD</sub> .....	-0.3V to +4V
AV <sub>DD</sub> Referenced to PV <sub>DD</sub> .....	-0.3V to +0.3V
SV <sub>SS</sub> , PV <sub>SS</sub> .....	-4V to +0.3V
SV <sub>SS</sub> Referenced to PV <sub>SS</sub> .....	-0.3V to +0.3V
DGND, PGND .....	-0.3V to +0.3V
BCLK, LRCLK, HPS, SDIN .....	-0.3V to (DV <sub>DD</sub> + 0.3V)
GPIO, MCLK .....	-0.3V to +4V
REF, PREG .....	-0.3V to (AV <sub>DD</sub> + 0.3V)
NREG .....	+0.3V to (SV <sub>SS</sub> - 0.3V)
SDA, SCL, ADD .....	-0.3V to +4V
INL, INR .....	-2V to +2V
HPR, HPL .....	(SV <sub>SS</sub> - 0.3V) to (AV <sub>DD</sub> + 0.3V)

OUTL, OUTR .....	(NREG - 0.3V) to (PREG + 0.3V)
C1N .....	(PV <sub>SS</sub> - 0.3V) to (PGND + 0.3V)
C1P .....	(PGND - 0.3V) to (PV <sub>DD</sub> + 0.3V)
Current Into/Out of Any Pin .....	100mA
Duration of HPL, HPR, OUTL, OUTR Short Circuit to AGND .....	Continuous
Continuous Power Dissipation (T <sub>A</sub> = +70°C)	
28-Pin Thin QFN (derate 35.7mW/°C above +70°C) .....	2857mW
Junction Temperature .....	+150°C
Operating Temperature Range .....	-40°C to +85°C
Storage Temperature Range .....	-65°C to +150°C
Lead Temperature (soldering, 10s) .....	+300°C

Stresses beyond those listed under "Absolute Maximum Ratings" may cause permanent damage to the device. These are stress ratings only, and functional operation of the device at these or any other conditions beyond those indicated in the operational sections of the specifications is not implied. Exposure to absolute maximum rating conditions for extended periods may affect device reliability.

## ELECTRICAL CHARACTERISTICS

(DV<sub>DD</sub> = AV<sub>DD</sub> = PV<sub>DD</sub> = 3.0V, AGND = DGND = PGND = 0V, C1 = 0.47μF, C2 = 2.2μF, C<sub>NREG</sub> = C<sub>PREG</sub> = C<sub>REF</sub> = 1μF to AGND, R<sub>LOAD\_HP</sub> = 32Ω to AGND, R<sub>LOAD\_OUT</sub> = 10kΩ to AGND, f<sub>LRCLK</sub> = 48kHz, f<sub>MCLK</sub> = 12.288MHz, volume set to -9.5dB, T<sub>A</sub> = T<sub>MIN</sub> to T<sub>MAX</sub>, unless otherwise noted. Typical specifications at T<sub>A</sub> = +25°C, unless otherwise noted.) (Note 1)

PARAMETER	SYMBOL	CONDITIONS		MIN	TYP	MAX	UNITS
Analog Supply Voltage	AV <sub>DD</sub> , PV <sub>DD</sub>	AV <sub>DD</sub> = PV <sub>DD</sub>		1.8		3.6	V
Digital Supply Voltage	DV <sub>DD</sub>			1.8		3.6	V
Analog Supply Current	AI <sub>DD</sub>	Full operation (Note 2), no headphone or line output load	AV <sub>DD</sub> = 1.8V	5.5	7.7	mA	
			AV <sub>DD</sub> = 3.0V	5.9			
		Full operation (Note 2), headphones disabled	AV <sub>DD</sub> = 1.8V	3.5	5.3		
			AV <sub>DD</sub> = 3.0V	3.75			
Digital Supply Current	DI <sub>DD</sub>	Full operation (Note 2), no line output load	DV <sub>DD</sub> = 1.8V	2.1	2.9	mA	
			DV <sub>DD</sub> = 3.0V	3.8			
Analog Shutdown Current	AI <sub>SHDN</sub>	I <sub>AVDD</sub> + I <sub>PVDD</sub> , AV <sub>DD</sub> = PV <sub>DD</sub> = 1.8V			1.5	10	μA
Digital Shutdown Current	DI <sub>SHDN</sub>	Static digital interface, DV <sub>DD</sub> = 1.8V			0.3	5	μA
Shutdown to Full Operation (Note 2)	t <sub>ON</sub>				1.3		ms
Power-On to Full Operation (Note 2)	t <sub>PON</sub>				1.4		ms
<b>DAC PERFORMANCE/LINE OUTPUTS</b> (Note 3)							
0dBFS Output Voltage	V <sub>OUT_FS</sub>			1.85	1.95	2.05	V <sub>P-P</sub>
Dynamic Range (Note 4)	DR	AV <sub>DD</sub> = 3.0V			87.5		dB
		AV <sub>DD</sub> = 1.8V		82	87.5		
Signal-to-Noise Ratio (Note 5)	SNR	Unweighted			88		dB
		A-weighted			91		
		AV <sub>DD</sub> = 1.8V, unweighted			88		
		AV <sub>DD</sub> = 1.8V, A-weighted			91		

# Stereo Audio DAC with DirectDrive Headphone Amplifier

**MAX9850**

## ELECTRICAL CHARACTERISTICS (continued)

(DVDD = AVDD = PVDD = 3.0V, AGND = DGND = PGND = 0V, C1 = 0.47μF, C2 = 2.2μF, CNREG = CPREG = CREF = 1μF to AGND, RLOAD\_HP = 32Ω to AGND, RLOAD\_OUT = 10kΩ to AGND, fLRCLK = 48kHz, fMCLK = 12.288MHz, volume set to -9.5dB, TA = TMIN to TMAX, unless otherwise noted. Typical specifications at TA = +25°C, unless otherwise noted.) (Note 1)

PARAMETER	SYMBOL	CONDITIONS	MIN	TYP	MAX	UNITS
Total Harmonic Distortion Plus Noise	THD+N	fIN = 984.375Hz	0dBFS	87		dB
			-60dBFS	27.5		
			AVDD = 1.8V, 0dBFS	-81		
			AVDD = 1.8V, -60dBFS	-27.5	-22	
Line Output Offset Voltage	VOS_LINE		-15	0	+15	mV
Channel-to-Channel Gain Matching	ΔAV/AV	OUTL to OUTR, OUTR to OUTL		±0.04		dB
Power-Supply Rejection Ratio	PSRR	VRIIPPLE = 100mVP-P, fIN = 1kHz, applied to AVDD and PVDD		87		dB
		VRIIPPLE = 100mVP-P, fIN = 20kHz, applied to AVDD and PVDD		67		
Crosstalk	XTALK	fOUT = 1kHz, VOUT = 2VP-P (OUTL to OUTR) or (OUTR to OUTL)		-105		dB
Sampling Frequency Range	fS		8		48	kHz
MCLK Frequency	fMCLK		8.448		40	MHz
<b>DAC 8x INTERPOLATION FILTER</b>						
Passband Frequency	PB	To -1dB corner	0		0.48 x fS	kHz
Frequency Response	FR	10Hz to 20kHz	-0.1		+0.1	dB
Stopband Attenuation	SBA		58			dB
Stopband Frequency	SB	Attenuation greater than SBA	0.58 x fS		7.42 x fS	kHz
<b>LINE INPUTS (INL, INR)</b>						
Line Input Voltage	VIN_LINE		-1		+1	V
IN_ to OUT_ Gain	AV_LINE		-1.05	-1	-0.95	V/V
Line Input Bias Voltage	VBIAS_LINE		-15	0	+15	mV
INL and INR Input Resistance	RIN_LINE		10	22		kΩ
<b>INTERNAL REGULATORS (NREG, PREG)</b>						
PREG Output Voltage	VPREG			1.60		V
NREG Output Voltage	VNREG			-1.15		V
REF Output Voltage	VREF			1.23		V

# Stereo Audio DAC with DirectDrive Headphone Amplifier

## ELECTRICAL CHARACTERISTICS (continued)

(DVDD = AVDD = PVDD = 3.0V, AGND = DGND = PGND = 0V, C1 = 0.47 $\mu$ F, C2 = 2.2 $\mu$ F, CNREG = CPREG = CREF = 1 $\mu$ F to AGND, RLOAD\_HP = 32 $\Omega$  to AGND, RLOAD\_OUT = 10k $\Omega$  to AGND, fLRCLK = 48kHz, fMCLK = 12.288MHz, volume set to -9.5dB, TA = TMIN to TMAX, unless otherwise noted. Typical specifications at TA = +25°C, unless otherwise noted.) (Note 1)

PARAMETER	SYMBOL	CONDITIONS		MIN	TYP	MAX	UNITS
<b>HEADPHONE OUTPUTS (HPL, HPR)</b>							
Output Power	OUT	THD+N = 1% f <sub>IN</sub> = 1kHz, headphone volume = +6dB	R <sub>L</sub> = 16 $\Omega$ AVDD = 3.0V		95		mW
			R <sub>L</sub> = 32 $\Omega$ AVDD = 3.0V	40	65		
			R <sub>L</sub> = 16 $\Omega$ AVDD = 1.8V		30		
			R <sub>L</sub> = 32 $\Omega$ AVDD = 1.8V	15	25		
Full-Scale Headphone Amplifier Output Voltage	V <sub>OUT_FS</sub>	Volume = +5dB, HP unloaded		1.16	1.23	1.30	V <sub>RMS</sub>
Line In to HP Output Voltage Gain	A <sub>V_HP</sub>	Volume = +3dB, HP unloaded		1.34	1.41	1.48	V/V
Total Harmonic Distortion Plus Noise	THD+N	R <sub>L</sub> = 32 $\Omega$ , P <sub>OUT</sub> = 60mW, f <sub>IN</sub> = 1kHz				-94	dB
		R <sub>L</sub> = 16 $\Omega$ , P <sub>OUT</sub> = 60mW, f <sub>IN</sub> = 1kHz				-90	
Signal-to-Noise Ratio (Note 6)	SNR	Unweighted				88	dB
		A-weighted				90	
		AVDD = 1.8V, unweighted				88	
		AVDD = 1.8V, A-weighted				91	
Power-Supply Rejection Ratio	PSRR	V <sub>RIPPLE</sub> = 100mV <sub>P-P</sub> , frequency = 1kHz, applied to AVDD and PVDD				91	dB
		V <sub>RIPPLE</sub> = 100mV <sub>P-P</sub> , frequency = 20kHz, applied to AVDD and PVDD				72	
Headphone Output Offset Voltage	V <sub>OS_HP</sub>	Volume = -11.5dB	TA = +25°C	-15		+15	mV
			TA = TMIN to TMAX	-25		+25	
Slew Rate	SR				0.47		V/ $\mu$ s
Maximum Capacitive Load	C <sub>L</sub>	No sustained oscillations			150		pF
Crosstalk	XTALK	R <sub>HP</sub> = 32 $\Omega$ , P <sub>OUT</sub> = 3.5mW, f <sub>IN</sub> = 1kHz (HPL to HPR) or (HPR to HPL)				-85	dB
Channel-to-Channel Gain Matching	$\Delta$ A <sub>v</sub> /A <sub>v</sub>					$\pm$ 0.05	dB
Internal Charge-Pump Oscillator Frequency	f <sub>CP</sub>			550	667	775	kHz
Charge-Pump Operating Frequency Range		Charge-pump clock derived from MCLK		550		775	kHz
Volume Control Range				-73.5		+6.0	dB

# Stereo Audio DAC with DirectDrive Headphone Amplifier

**MAX9850**

## ELECTRICAL CHARACTERISTICS (continued)

(DVDD = AVDD = PVDD = 3.0V, AGND = DGND = PGND = 0V, C1 = 0.47μF, C2 = 2.2μF, CNREG = CPREG = CREF = 1μF to AGND, RLOAD\_HP = 32Ω to AGND, RLOAD\_OUT = 10kΩ to AGND, fLRCLK = 48kHz, fMCLK = 12.288MHz, volume set to -9.5dB, TA = TMIN to TMAX, unless otherwise noted. Typical specifications at TA = +25°C, unless otherwise noted.) (Note 1)

PARAMETER	SYMBOL	CONDITIONS	MIN	TYP	MAX	UNITS
Mute Attenuation				100		dB
<b>DIGITAL INPUTS (GPIO, SCL, SDA, BCLK, LRCLK, SDIN, ADD, MCLK)</b>						
Input High Voltage	V <sub>IH</sub>		0.8 x DVDD			V
Input Low Voltage	V <sub>IL</sub>			0.2 x DVDD		V
Input Leakage Current	I <sub>IH</sub> , I <sub>IL</sub>	V <sub>IH</sub> = DVDD, V <sub>IL</sub> = DGND	-10		+10	μA
Input Hysteresis				0.09 x DVDD		V
Input Capacitance	C <sub>IN</sub>			10		pF
<b>OPEN-DRAIN DIGITAL OUTPUTS (GPIO, SDA)</b>						
Output-High Leakage Current	I <sub>OH</sub>	V <sub>OH</sub> = DVDD (Note 7)			1	μA
Output Low Voltage	V <sub>OL</sub>	I <sub>OL</sub> = 3mA	DVDD > 2V		0.4	V
			DVDD < 2V		0.2 x DVDD	
<b>CMOS DIGITAL OUTPUTS (BCLK, LRCLK)</b>						
Output High Voltage	V <sub>OH</sub>	I <sub>OH</sub> = 1mA	DVDD - 0.4			V
Output Low Voltage	V <sub>OL</sub>	I <sub>OL</sub> = 1mA			0.4	V
<b>HEADPHONE SENSE INPUT (HPS)</b>						
Input High Voltage	V <sub>IH</sub>		0.7 x DVDD			V
Input Low Voltage	V <sub>IL</sub>			0.25 x DVDD		V
Input-High Leakage Current	I <sub>IH</sub>	Full shutdown, V <sub>IH</sub> = DVDD		400		μA
		Normal operation, V <sub>IH</sub> = DVDD		1		
Input-Low Leakage Current	I <sub>IL</sub>	Full shutdown, V <sub>IL</sub> = DGND		1		μA
		Normal operation, V <sub>IL</sub> = DGND		100		
Input Hysteresis				0.05 x DVDD		V

# Stereo Audio DAC with DirectDrive Headphone Amplifier

## TIMING CHARACTERISTICS

(DV<sub>DD</sub> = AV<sub>DD</sub> = PV<sub>DD</sub> = 3.0V, AGND = DGND = PGND = 0V, C1 = 0.47μF, C2 = 2.2μF, C<sub>NREG</sub> = C<sub>PREG</sub> = C<sub>REF</sub> = 1μF to AGND, R<sub>LOAD\_HP</sub> = 32Ω to AGND, R<sub>LOAD\_LINE</sub> = 10kΩ to AGND, f<sub>LRCLK</sub> = 48kHz, f<sub>MCLK</sub> = 12.288MHz, volume set to -9.5dB, T<sub>A</sub> = T<sub>MIN</sub> to T<sub>MAX</sub>, unless otherwise noted. Typical specifications at T<sub>A</sub> = +25°C, unless otherwise noted.) (Note 1)

PARAMETER	SYMBOL	CONDITIONS	MIN	TYP	MAX	UNITS
<b>I<sup>2</sup>C TIMING</b>						
Serial Clock Frequency	f <sub>SCL</sub>		0		400	kHz
Bus Free Time Between STOP and START Conditions	t <sub>BUF</sub>		1.3			μs
Hold Time (Repeated) START Condition	t <sub>HD, STA</sub>		0.6			μs
SCL Pulse-Width Low	t <sub>LOW</sub>		1.3			μs
SCL Pulse-Width High	t <sub>HIGH</sub>		0.6			μs
Repeated START Condition Setup Time	t <sub>SU, STA</sub>		0.6			μs
Data Hold Time	t <sub>HD, DAT</sub>		0		900	ns
Data Setup Time	t <sub>SU, DAT</sub>		100			ns
Bus Capacitance	C <sub>B</sub>				400	pF
SDA and SCL Receiving Rise Time (Note 8)	t <sub>R</sub>		20 + 0.1C <sub>B</sub>		300	ns
SDA and SCL Receiving Fall Time (Note 8)	t <sub>F</sub>		20 + 0.1C <sub>B</sub>		300	ns
SDA Transmitting Fall Time (Note 8)	t <sub>F</sub>	DV <sub>DD</sub> = 1.8V, T <sub>A</sub> = +25°C	20 + 0.1C <sub>B</sub>		250	ns
		DV <sub>DD</sub> = 3.6V, T <sub>A</sub> = +25°C	20 + 0.05C <sub>B</sub>		250	
Setup Time for STOP Condition	t <sub>SU, STO</sub>		0.6			μs
Pulse Width of Suppressed Spike	t <sub>SP</sub>		0		50	ns
<b>DIGITAL AUDIO TIMING</b>						
BCLK Period (Note 9)	t <sub>BCLK</sub>		3 x 1 / f <sub>ICLK</sub>			ns
Low or High BCLK Pulse Width	t <sub>BCLK_PW</sub>		0.35 x t <sub>BCLK</sub>			ns
BCLK and LRCLK Rise Time	t <sub>R</sub>	Master mode, C <sub>LOAD</sub> = 15pF	1			ns
BCLK and LRCLK Fall Time	t <sub>F</sub>	Master mode, C <sub>LOAD</sub> = 15pF	1			ns
SDIN or LRCLK to BCLK Rising Setup Time	t <sub>DBSU,</sub> t <sub>BWSU</sub>		30			ns
SDIN or LRCLK to BCLK Rising Hold Time	t <sub>DBH,</sub> t <sub>BWBH</sub>	DV <sub>DD</sub> = 1.8V			0	ns
		DV <sub>DD</sub> = 3.6V			5	

**Note 1:** The MAX9850 is 100% production tested at T<sub>A</sub> = +25°C and is guaranteed by design for T<sub>A</sub> = T<sub>MIN</sub> to T<sub>MAX</sub>.

**Note 2:** Full operation is defined as clocking all zeros into the DAC while the DAC, headphone outputs, and line outputs are all enabled.

**Note 3:** DAC performance specifications measured using the line outputs, OUTL and OUTR.

**Note 4:** Dynamic range is defined as the SNR of a 1kHz, -60dBFS input signal measured with an A-weighted filter, then normalized to full scale (+60dB).

# Stereo Audio DAC with DirectDrive Headphone Amplifier

MAX9850

- Note 5:** DAC SNR measured from DAC inputs to OUTL and OUTF.
- Note 6:** Headphone amplifier SNR measured from line inputs to headphone outputs.
- Note 7:** GPIO is 100kΩ to ground when DVDD < VOH < 3.6V.
- Note 8:** CB is in pF.
- Note 9:** f<sub>CLK</sub> derived by dividing f<sub>MCLK</sub> by 1, 2, 3, or 4. See the *Registers and Bit Descriptions* section.

## TYPICAL POWER DISSIPATION AT AVDD = 1.8V (No Headphone/Line Output Load)

MODE	AVDD POWER	DVDD POWER	PVDD POWER	TOTAL POWER
Full Operation (Note 1)	4.93mW	3.76mW	5.00mW	13.70mW
DAC to Line Outputs, Headphones Disabled	3.11mW	3.76mW	3.22mW	10.10mW
Line Inputs to Line Outputs and Headphone Outputs, DAC Disabled	3.22mW	0.085mW	3.40mW	6.71mW
Line Inputs to Line Outputs, DAC and Headphones Disabled	1.39mW	0.085mW	1.61mW	3.08mW
Full Shutdown	2.7μW	0.5μW	<0.1μW	3.2μW

## Typical Operating Characteristics

(DVDD = AVDD = PVDD = 3.0V, AGND = DGND = PGND = 0V, C1 = 0.47μF, C2 = 2.2μF, CNREG = CPREG = CREF = 1μF, fs = 48kHz, f<sub>MCLK</sub> = 12.288MHz, master integer mode, headphone volume set to +6dB, both channels driven in-phase, TA = +25°C, unless otherwise noted. f<sub>IN</sub> = 984.375Hz, A-weighted THD+N.)

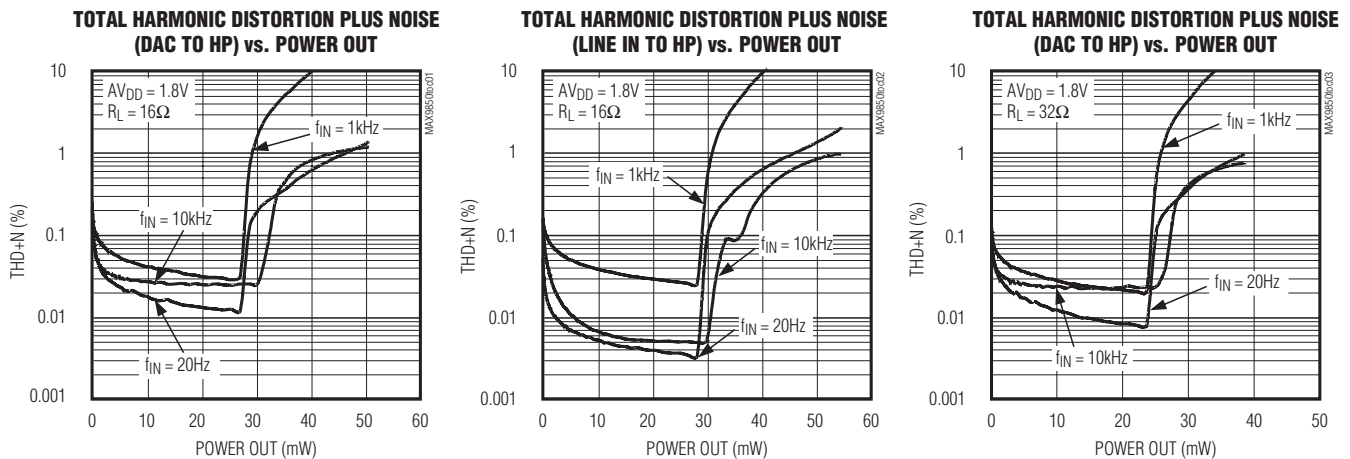

# Stereo Audio DAC with DirectDrive Headphone Amplifier

## Typical Operating Characteristics (continued)

( $V_{DD} = AV_{DD} = PV_{DD} = 3.0V$ ,  $AGND = DGND = PGND = 0V$ ,  $C1 = 0.47\mu F$ ,  $C2 = 2.2\mu F$ ,  $C_{NREG} = C_{PREG} = C_{REF} = 1\mu F$ ,  $f_s = 48kHz$ ,  $f_{MCLK} = 12.288MHz$ , master integer mode, headphone volume set to +6dB, both channels driven in-phase,  $T_A = +25^\circ C$ , unless otherwise noted.  $f_{IN} = 984.375Hz$ , A-weighted THD+N.)

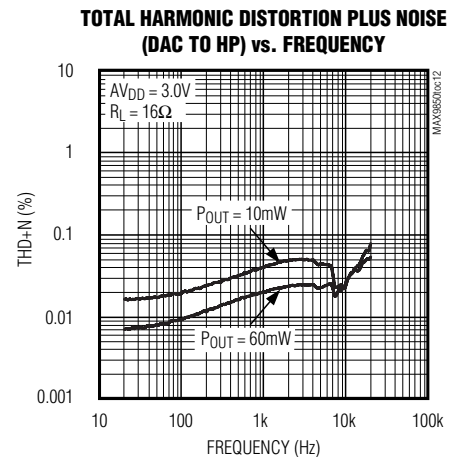
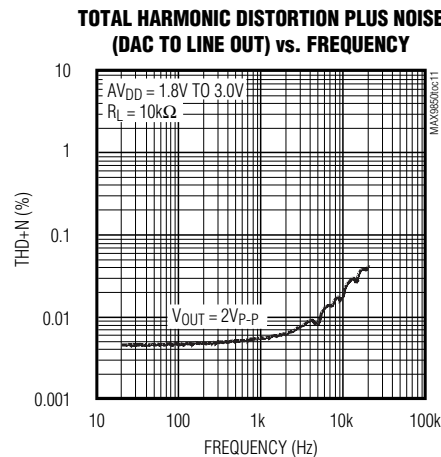
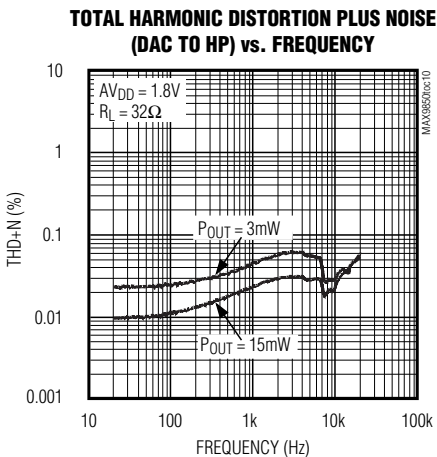
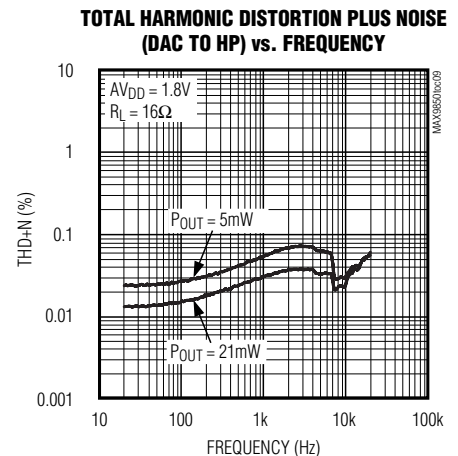
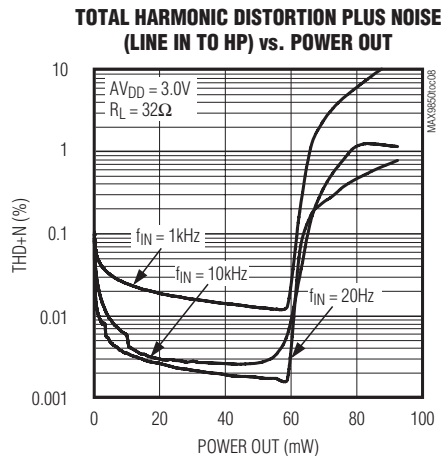
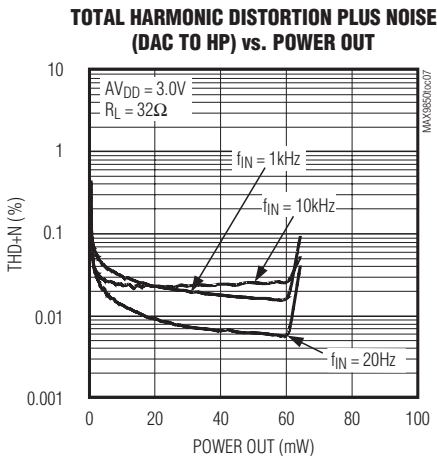
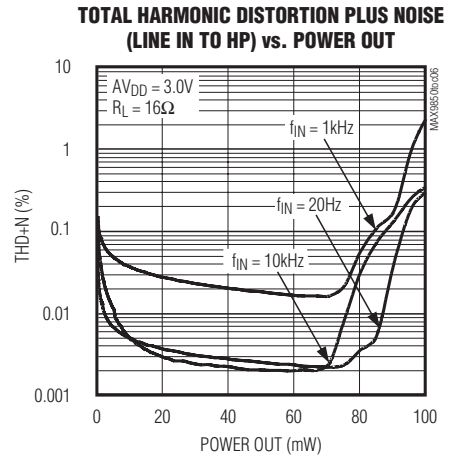
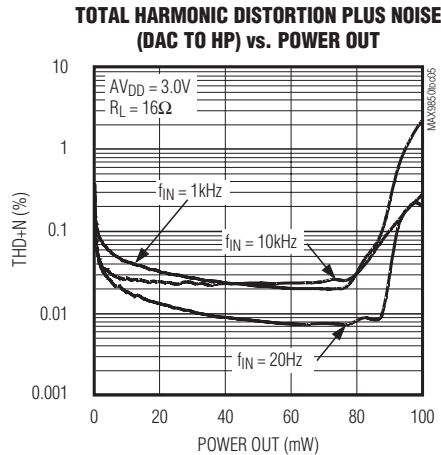
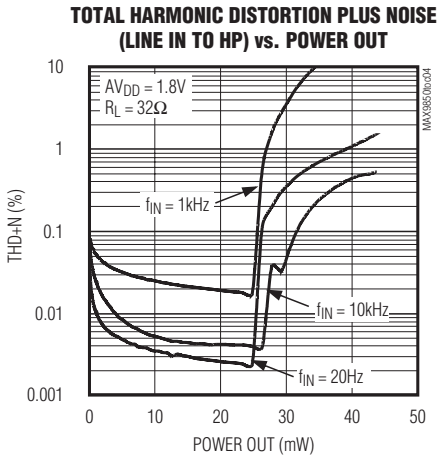



# Stereo Audio DAC with DirectDrive Headphone Amplifier

MAX9850

## Typical Operating Characteristics (continued)

( $DV_{DD} = AV_{DD} = PV_{DD} = 3.0V$ ,  $AGND = DGND = PGND = 0V$ ,  $C1 = 0.47\mu F$ ,  $C2 = 2.2\mu F$ ,  $C_{NREG} = C_{PREG} = C_{REF} = 1\mu F$ ,  $f_S = 48kHz$ ,  $f_{MCLK} = 12.288MHz$ , master integer mode, headphone volume set to +6dB, both channels driven in-phase,  $T_A = +25^\circ C$ , unless otherwise noted.  $f_{IN} = 984.375Hz$ , A-weighted THD+N.)

**TOTAL HARMONIC DISTORTION PLUS NOISE (DAC TO HP) vs. FREQUENCY**

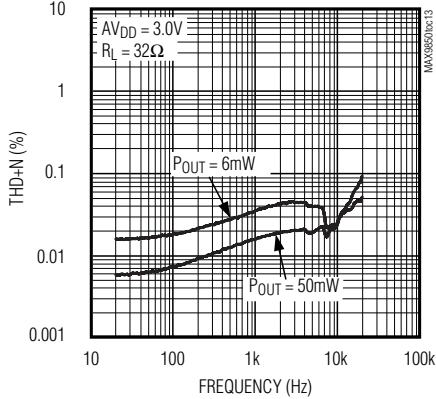

**POWER DISSIPATION vs. POWER OUT**

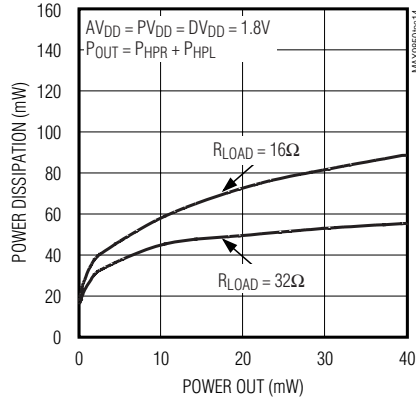

**POWER DISSIPATION vs. POWER OUT**

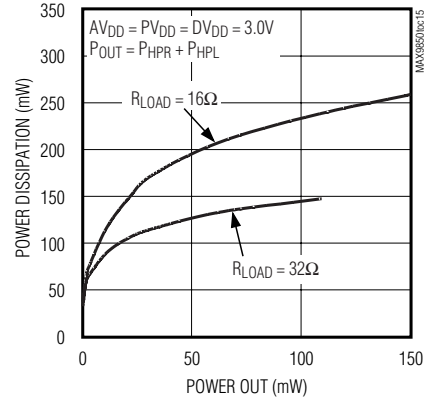

**POWER OUT vs. HEADPHONE LOAD**

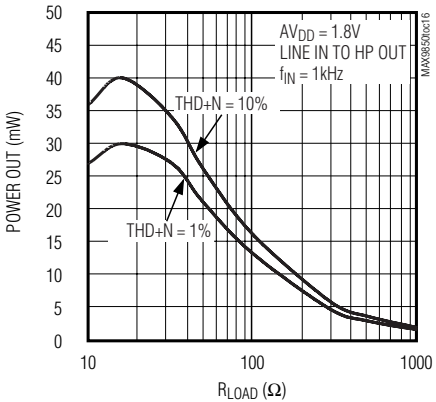

**POWER OUT vs. HEADPHONE LOAD**

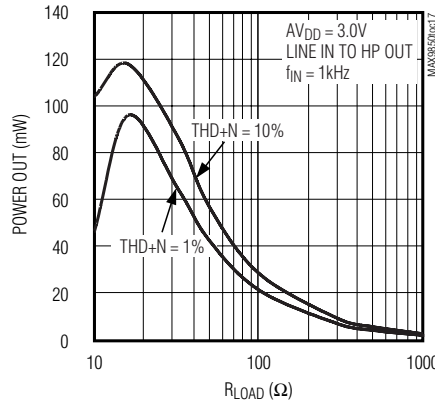

**POWER OUT vs. SUPPLY VOLTAGE**

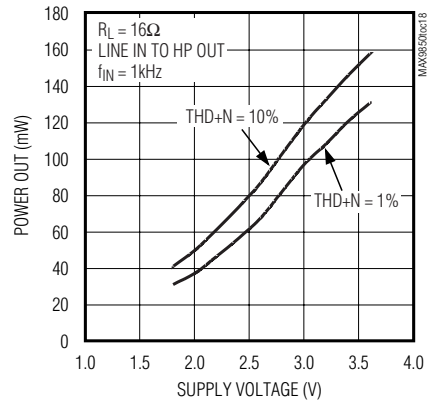

**POWER OUT vs. SUPPLY VOLTAGE**

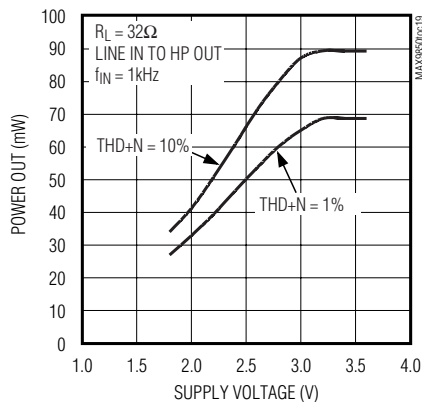

**POWER-SUPPLY REJECTION RATIO vs. FREQUENCY (DAC TO HP)**

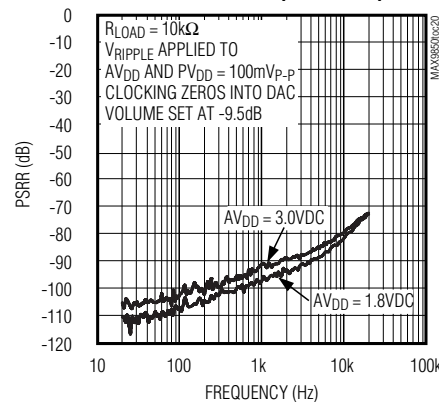

**POWER-SUPPLY REJECTION RATIO vs. FREQUENCY (DAC TO LINE OUT)**

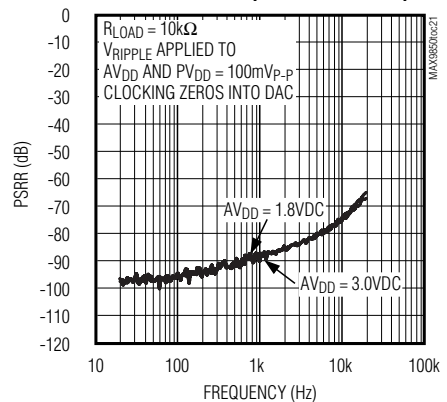

# Stereo Audio DAC with DirectDrive Headphone Amplifier

## Typical Operating Characteristics (continued)

( $V_{DD} = AV_{DD} = PV_{DD} = 3.0V$ ,  $AGND = DGND = PGND = 0V$ ,  $C_1 = 0.47\mu F$ ,  $C_2 = 2.2\mu F$ ,  $C_{NREG} = C_{PREG} = C_{REF} = 1\mu F$ ,  $f_S = 48kHz$ ,  $f_{MCLK} = 12.288MHz$ , master integer mode, headphone volume set to +6dB, both channels driven in-phase,  $T_A = +25^\circ C$ , unless otherwise noted.  $f_{IN} = 984.375Hz$ , A-weighted THD+N.)

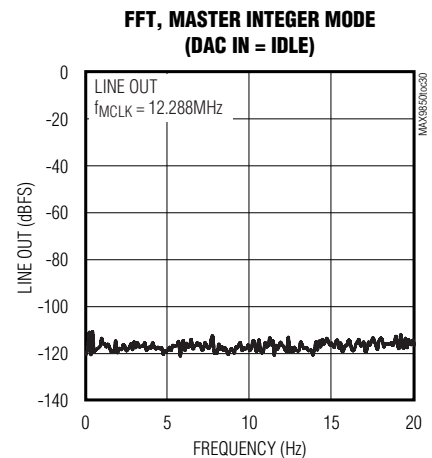
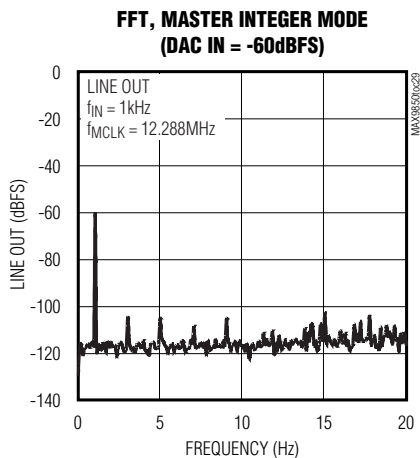
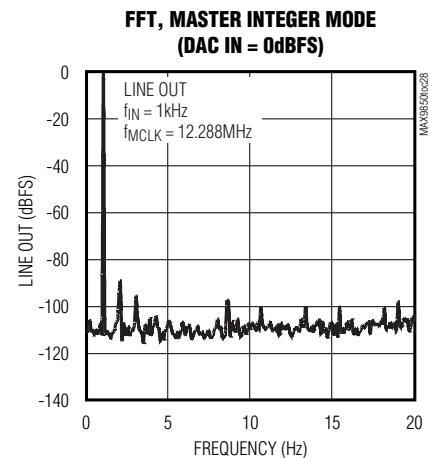
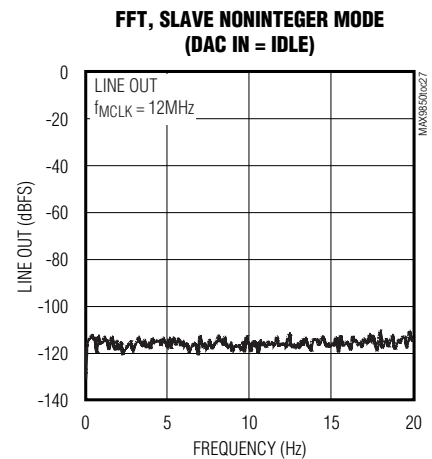
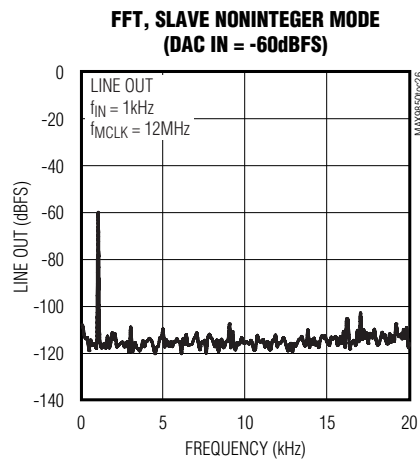
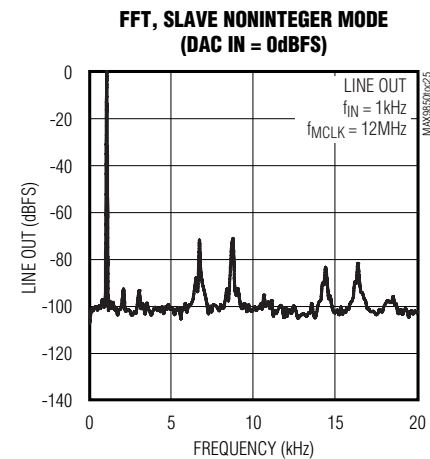
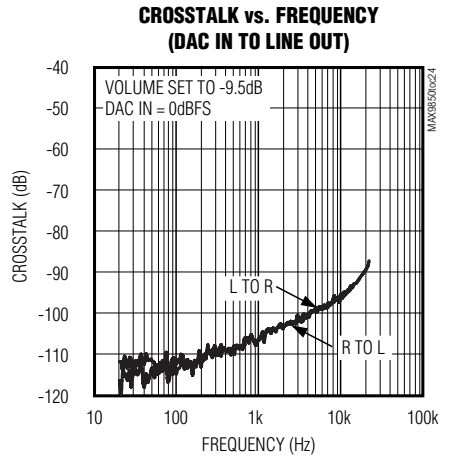
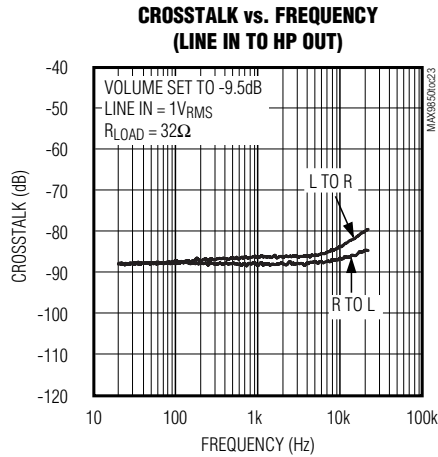
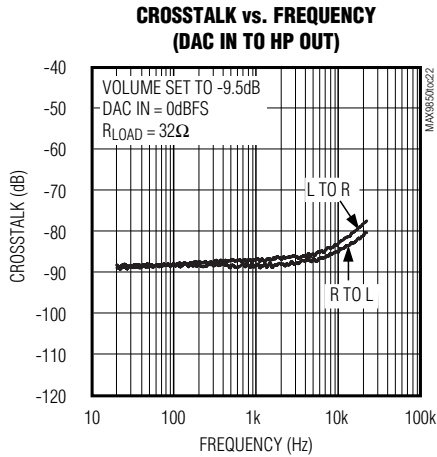

# Stereo Audio DAC with DirectDrive Headphone Amplifier

MAX9850

## Typical Operating Characteristics (continued)

( $DV_{DD} = AV_{DD} = PV_{DD} = 3.0V$ ,  $AGND = DGND = PGND = 0V$ ,  $C1 = 0.47\mu F$ ,  $C2 = 2.2\mu F$ ,  $C_{NREG} = C_{PREG} = C_{REF} = 1\mu F$ ,  $f_S = 48kHz$ ,  $f_{MCLK} = 12.288MHz$ , master integer mode, headphone volume set to +6dB, both channels driven in-phase,  $T_A = +25^\circ C$ , unless otherwise noted.  $f_{IN} = 984.375Hz$ , A-weighted THD+N.)

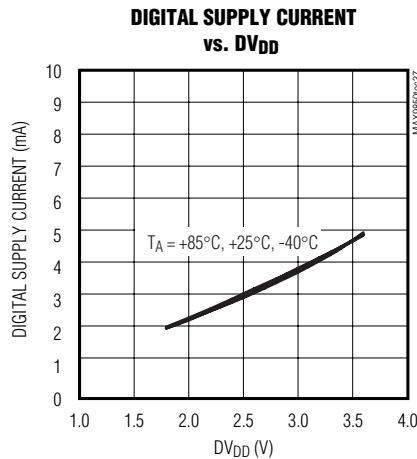
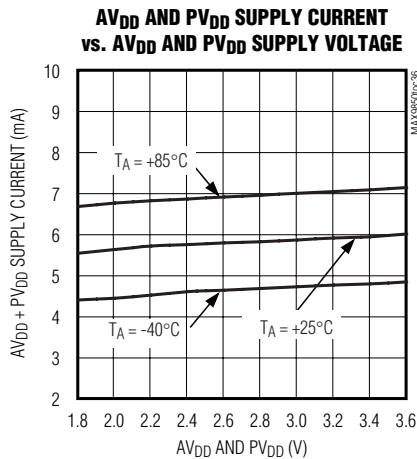
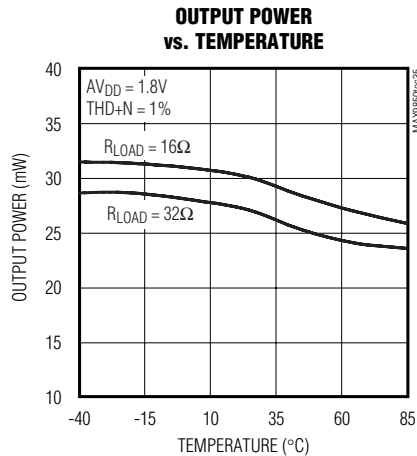
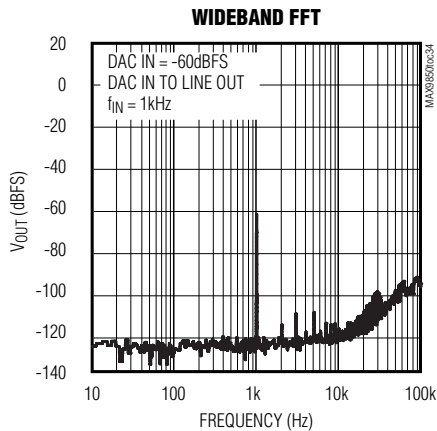
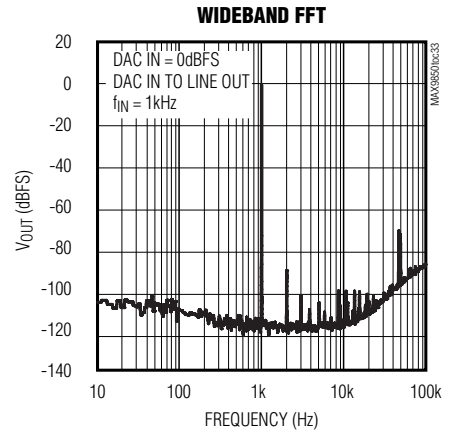
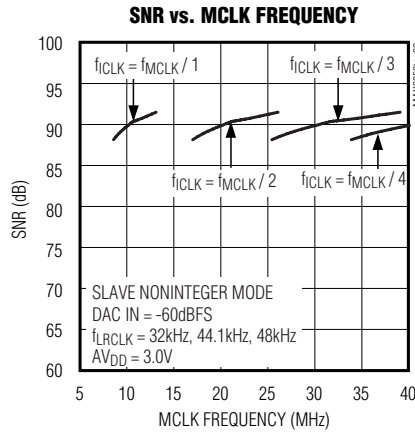
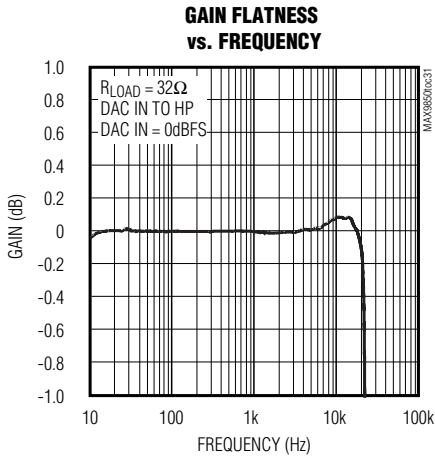

# Stereo Audio DAC with DirectDrive Headphone Amplifier

## Pin Description

PIN	NAME	FUNCTION
1	LRCLK	Digital Audio Left-Right Clock Input/Output. LRCLK is the audio sample rate clock and determines whether the audio data on SDIN is routed to the left or right channel. LRCLK is an input when the MAX9850 is in slave mode and an output when in master mode.
2	BCLK	Digital Audio Bit Clock Input/Output. BCLK is an input when the MAX9850 is in slave mode and an output when in master mode.
3	SDIN	Digital Audio Serial Data Input
4	DVDD	Digital Power-Supply Input. Bypass to DGND with a 1 $\mu$ F ceramic capacitor.
5	MCLK	Master Clock Input. All internal digital clocks are derived from MCLK.
6	DGND	Digital Ground
7	ADD	I <sup>2</sup> C Address-Select Input. Connect to AGND, AVDD, or SDA to select one of the three possible I <sup>2</sup> C addresses.
8	GPIO	General-Purpose Input/Output. Configure GPIO as an input or an output through the GPIO register. GPIO can perform the function of an interrupt when configured as an output. See the <i>GPIO</i> section.
9	INR	Right-Channel Line Input. INR is mixed with the right DAC output.
10	INL	Left-Channel Line Input. INL is mixed with the left DAC output.
11	OUTR	Line Level Right-Channel Output. OUTR is biased at AGND.
12	OUTL	Line Level Left-Channel Output. OUTL is biased at AGND.
13	REF	Reference Output. Bypass to AGND with a 1 $\mu$ F ceramic capacitor.
14	AGND	Analog Ground
15	NREG	Line Output Negative Regulator Output. Bypass to AGND with a 1 $\mu$ F capacitor.
16	PREG	Line Output Positive Regulator Output. Bypass to AGND with a 1 $\mu$ F capacitor.
17	AVDD	Analog Power Supply. Bypass to AGND with a 1 $\mu$ F ceramic capacitor.
18	HPR	Right-Channel Headphone Output. HPR is a DirectDrive output biased at AGND.
19	HPL	Left-Channel Headphone Output. HPL is a DirectDrive output biased at AGND.
20	SVSS	Headphone Amplifier Negative Power-Supply Input. Connect to PVSS.
21	HPS	Headphone Sense Input. Connect to the control pin of a headphone jack for automatic headphone sensing. Float HPS if unused. See the <i>Headphone Sense Input (HPS)</i> section.
22	PVSS	Inverting Charge-Pump Output. Bypass to PGND with a 2.2 $\mu$ F ceramic capacitor and connect to SVSS to provide the headphone amplifiers with a negative supply.
23	C1N	Charge-Pump Flying Capacitor Negative Terminal. Connect a 0.47 $\mu$ F ceramic capacitor between C1N and C1P.
24	PGND	Charge-Pump Ground
25	C1P	Charge-Pump Flying Capacitor Positive Terminal. Connect a 0.47 $\mu$ F ceramic capacitor between C1P and C1N.
26	PVDD	Charge-Pump and Headphone Amplifier Positive Power-Supply Input. Bypass to PGND with a 1 $\mu$ F ceramic capacitor. Connect to AVDD for normal operation.
27	SCL	I <sup>2</sup> C-Compatible Serial Clock Input
28	SDA	I <sup>2</sup> C-Compatible Serial Data Input/Output
—	EP	Exposed Thermal Pad. Connect EP to AGND.

# Stereo Audio DAC with DirectDrive Headphone Amplifier

## Functional Diagram/Typical Operating Circuit

**MAX9850**

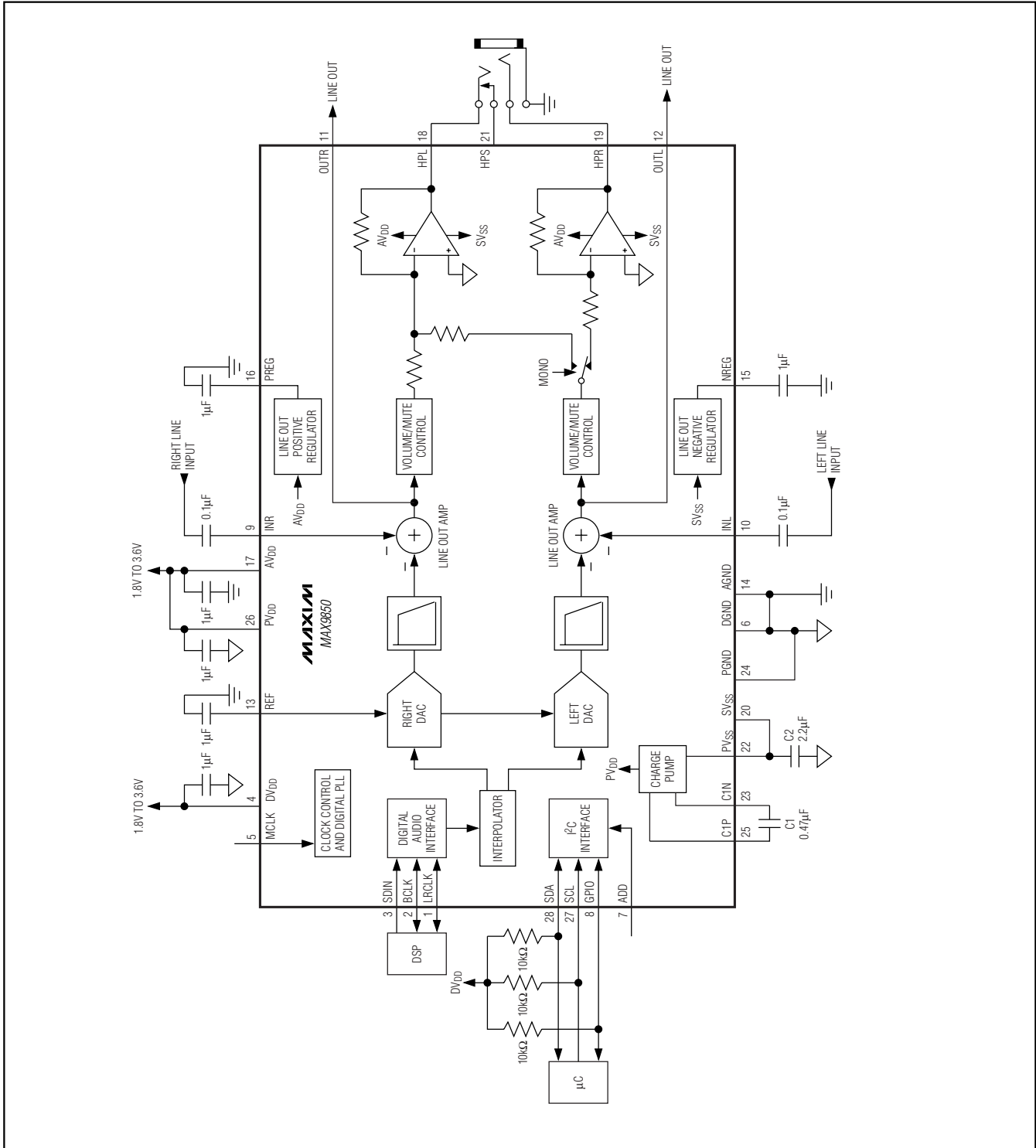

# Stereo Audio DAC with DirectDrive Headphone Amplifier

## Detailed Description

The MAX9850 audio digital-to-analog converter (DAC) with a stereo DirectDrive headphone amplifier is a complete digital audio playback solution. The sigma-delta DAC has 90dB of dynamic range and accepts stereo audio data at sampling frequencies ranging from 8kHz to 48kHz. Headphone output volume level, muting, and device configuration are programmed through the I<sup>2</sup>C-compatible interface. Three selectable I<sup>2</sup>C device IDs are available. Both basic modes of operation, integer and noninteger, provide full dynamic range performance and allow maximum flexibility when choosing the MAX9850's master clock (MCLK) frequency. Integer mode operation requires that MCLK is an integer multiple of 16 times the sample rate, and provides maximum full-scale SNR performance. Noninteger mode allows maximum flexibility when choosing an MCLK frequency, as the MCLK may be any frequency in the acceptable range.

Audio data is sent to the MAX9850 through a 3-wire digital audio data bus that supports numerous input formats. LRCLK and BCLK signals are generated by the MAX9850 when configured in master mode. The MAX9850 can also be configured as a slave device, accepting LRCLK and BCLK signals from an external digital audio master. External LRCLK and BCLK signals may be either synchronous or asynchronous with MCLK when the MAX9850 is configured as a slave device.

Maxim's DirectDrive architecture employs an internal charge pump to create a negative voltage supply to power the headphone amplifier outputs. The internal negative supply allows the analog output signals to be biased at ground, eliminating the need for an output-coupling capacitor, reducing system cost and size.

The MAX9850's stereo line inputs allow mixing of analog audio with digital audio. The summed audio signal is sent directly to the line and headphone outputs. The line inputs/outputs can be activated even when the DAC is disabled and MCLK is not present.

The headphone sense input (HPS) detects when a headphone is connected to the MAX9850. The HPS circuit shuts down the headphone amplifier outputs when no headphones are connected. The headphone amplifiers can be automatically enabled when HPS detects the presence of headphones.

### Sigma-Delta DAC

The MAX9850 uses a sigma-delta DAC to achieve up to 91dB of SNR. The DAC receives a stereo digital input signal sampled at  $f_{LRCLK}$ , interpolates the signal data to an 8 times  $f_{LRCLK}$  frequency, and digitally filters the

samples. The resulting oversampled digital signal is then converted using a multibit sigma-delta modulator followed by an analog smoothing filter that greatly attenuates high-frequency quantization noise typical with oversampling converters. Flexible clocking modes allow the MAX9850 to be used effectively in applications normally not well suited for oversampling converters all without the need for expensive sample rate converters.

Set DACEN = 0 in the enable register (register 0x5, bit B0) to disable the DAC. Set DACEN = 1 to enable the DAC.

### Line Outputs/Inputs

The MAX9850 features line inputs (INR, INL) and line outputs (OUTR, OUTL). The line inputs allow a line level signal to be mixed with the DAC output, see the *Functional Diagram/Typical Operating Circuit*. Set LNIEN = 1 in the enable register (register 0x5, bit B1) to enable the line inputs. The line inputs are biased at AGND and can be directly coupled or AC-coupled to INR and INL, depending on the signal source.

Stereo DirectDrive line outputs (OUTR and OUTL) can be used to drive line-level loads. Line outputs internally drive the inputs of the headphone amplifier. Set LNOEN = 1 in the enable register (register 0x5, bit B2) to enable the line outputs. Disabling the line outputs will also disable the headphone outputs.

The internal charge pump must be enabled to operate the line outputs. Enable the charge pump by configuring CPEN(1:0) = 11 in the enable register (register 0x5, bit B5 and B4). See the *Charge Pump* section.

### DirectDrive Headphone and Line Amplifiers

Unlike the MAX9850, traditional single-supply headphone amplifiers have their outputs biased about a nominal DC voltage, typically half the supply, for maximum dynamic range. Large coupling capacitors are typically needed to block this DC bias from the headphone. Without these capacitors, a significant amount of DC current flows to the headphone, resulting in unnecessary power dissipation and possible damage to both headphone and headphone amplifier.

Maxim's patented DirectDrive architecture uses a charge pump to create an internal negative supply voltage. This allows the MAX9850 headphone and line outputs to be biased about ground, almost doubling the dynamic range while operating from a single supply. With no DC component, there is no need for the large DC-blocking capacitors. Instead of two large (33 $\mu$ F to 330 $\mu$ F) capacitors, the MAX9850 charge pump

# Stereo Audio DAC with DirectDrive Headphone Amplifier

MAX9850

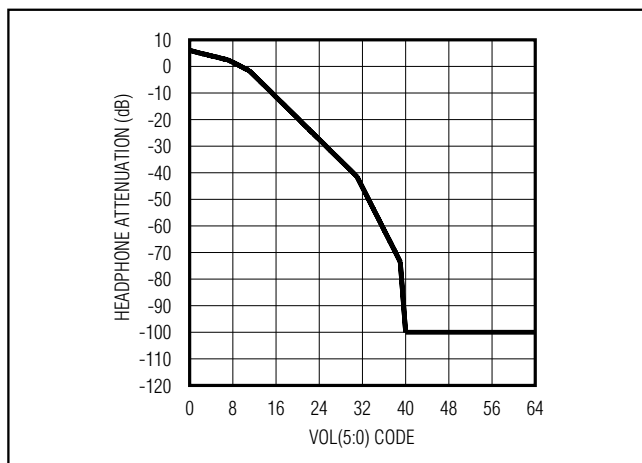

Figure 1. Headphone Amplifier Attenuation Profile

requires only two small ceramic capacitors (0.47 $\mu$ F and 2.2 $\mu$ F), conserving board space, reducing cost, improving the frequency response, and THD of the headphone amplifier. In addition to the cost and size disadvantages, the DC-blocking capacitors required by conventional headphone amplifiers limit low-frequency response and decrease PSRR performance. Some dielectrics can significantly distort the audio signal.

### Volume Control

Program VOL(5:0) in the volume register (register 0x2, bits B5–B0) to set the volume attenuation of the headphone amplifiers. Program VOL(5:0) to 0x00 for full volume. Minimum volume occurs at VOL(5:0) greater than or equal to 0x28. VMN in the status A register (register 0x0, bit B3) sets to 1 when the MAX9850 output is programmed to and reaches volume step 0x3F. Figure 1 shows the attenuation profile for each VOL(5:0) value.

### Volume Slew, Zero-Crossing Detect, and Mute

Set SLEW = 1 in the volume register (register 0x2, bit B6) to enable the volume slew circuit. When SLEW = 1 headphone amplifier volume changes will slew between programmed levels smoothly. Set the volume slew rate with SR(1:0) in the charge-pump register (register 0x7, bits B7 and B6). Table 1 lists the volume slew-rate settings for each value of SR(1:0).

Set ZDEN = 1 in the general-purpose register (register 0x3, bit B0) to force volume changes and headphone amplifier muting to occur when the audio signal is at its zero crossing. For optimal performance, set SR(1:0) to 01. This zero-crossing detection reduces audible clicks/pops caused when transitioning or slewing between volume levels.

Table 1. Slew-Rate Settings

SR1	SR0	TYPICAL VOLUME SLEW RATE	
		FROM FULL VOLUME TO MUTE	FROM FULL VOLUME TO VMN = 1 (ms)
0	0	63 $\mu$ s	0.1
0	1	125ms	200
1	0	63ms	100
1	1	42ms	67

Set MUTE = 1 in the volume register (register 0x2, bit B7) to mute the headphone amplifiers. The mute function is independent of the volume control. The programmed volume settings are not reset when mute is enabled. With the zero-crossing detection and volume slew enabled, the Mute command mutes the output after the first zero crossing or after a 200ms timeout (SR = 01).

### Mono Mode

Set MONO = 1 in the general-purpose register (register 0x3, bit B2) to enable mono mode. In mono mode, HPR is disabled, the left and right audio channels are summed and output on HPL. The 6dB attenuation ensures that the summed signal amplitude does not overdrive headphone amplifiers. SMONO in the status B register (register 0x1, bit B4) sets to 1 when the MAX9850 is in mono mode.

### Configuring the Headphone and Line Outputs

Set HPEN and LNOEN in the enable register (register 0x5, bits B3 and B2) equal to 1 to enable the headphone outputs (HPR and HPL). Set HPEN or LNOEN = 0 to disable the headphone outputs.

The headphone amplifier inputs are driven from the outputs of the line amplifier. Disabling the line out by setting LNOEN = 0 in the enable register (register 0x5, bit B2), deprives the headphone amplifiers of an input signal and disables the headphone outputs (HPR and HPL).

The internal charge pump must be enabled to operate the headphone and line outputs. Enable the charge pump by programming CPEN(1:0) = 11 in the enable register (register 0x5, bits B5 and B4). See the *Charge Pump* section for more details.

### Headphone Sense Input (HPS)

The headphone sense input (HPS) monitors the headphone jack, and automatically disables the headphone amplifiers based upon the voltage applied at HPS. For automatic headphone detection, connect HPS to the

# Stereo Audio DAC with DirectDrive Headphone Amplifier

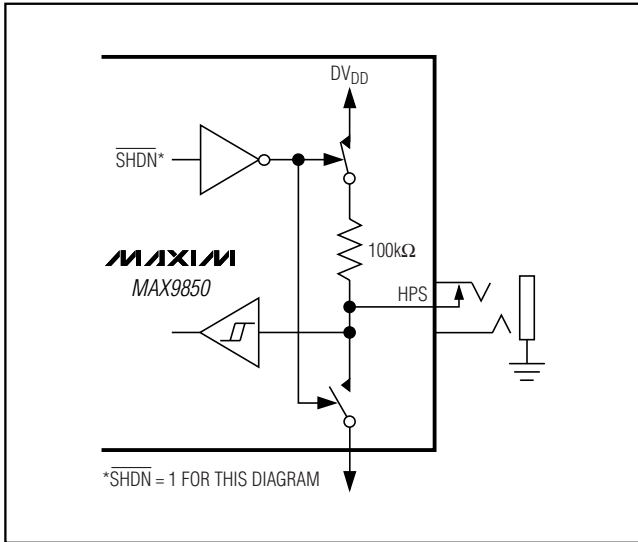

Figure 2. Headphone Sense (HPS) Input

control pin of a 3-wire headphone jack as shown in Figure 2. With no headphone present, the output impedance of the headphone amplifier pulls HPS to less than  $0.3 \times DV_{DD}$ . When a headphone is inserted into the jack, the control pin is disconnected from the tip contact and HPS is pulled to  $DV_{DD}$  through the internal  $100k\Omega$  pullup. No external resistor is required. Leave HPS floating if automatic headphone sensing is not used. HPS must be high and HPEN (register 0x5, bit B3) must be set to 1 for the headphone amplifiers (HPR and HPL) to output an audio signal.

The MAX9850 includes an HPS debounce circuit that ignores short duration changes on HPS. The debounce circuit ensures that a headphone is properly connected before powering up and enabling the headphone amplifiers. Program DBDEL(1:0) in the general-purpose register (register 0x3, bits B4 and B3) to set the HPS debounce delay time. The delay time is based on a division of the charge-pump frequency,  $f_{CP}$ . See the *Charge Pump* section for details on programming the charge-pump frequency. Table 2 lists the available delay times of the debounce circuit.

There is no delay on removal of a headphone when using automatic headphone sense. The headphone amplifiers are immediately placed into shutdown when HPS goes high.

SHPS in the status A register (register 0x0, bit B4) reports the status of HPS. SHPS = 0 when HPS is low and SHPS = 1 when HPS is high.

Table 2. HPS Debounce Times

DBDEL(0)	DBDEL(1)	DEBOUNCE TIME (ms)	DEBOUNCE TIME BASED ON $f_{CP} = 667kHz$ (ms)
0	0	0	0 (Disabled)
0	1	$2^{17} \times 1 / f_{CP}$	Approx 200
1	0	$2^{18} \times 1 / f_{CP}$	Approx 400
1	1	$2^{19} \times 1 / f_{CP}$	Approx 800

## GPIO

Configure GPIO as an input or an output with the GPD bit in the general-purpose register (register 0x3, bit B5). GPD = 1 configures GPIO as an open-drain output while GPD = 0 makes GPIO an input. Connect an external pullup resistor from GPIO to  $DV_{DD}$  when GPIO is configured as an output.

GPIO as an output allows the MAX9850 to drive an LED or other state indicator. It also can be used to provide an interrupt signal to alert a  $\mu C$  when an event has occurred. Potential events include changes in internal PLL lock state, connecting headphones to HPS, headphone outputs reaching the minimum volume, or an overcurrent on the headphone outputs. Any of these events can be programmed to pulse GPIO's output state when GPIO is configured as an open-drain output.

Using GPIO as an input allows the MAX9850 to receive a signal from a  $\mu C$ 's digital I/O or other device. The status of GPIO is read through SGPIO in the status A register (register 0x0, bit B6).

## GPIO as an Output

Set GPD = 1 (register 0x3, bit B5) to configure GPIO as an output. Program the output operating mode of GPIO with GM(1:0) in the general-purpose register (register 0x3, bits B7 and B6). GPIO can be programmed to output logic-high, a logic-low, or it can be programmed to output an interrupt signal by changing state when the ALERT bit in the status A register (register 0x0, bit B7) sets. Table 3 lists GPIO's modes of operation.

Table 3. GPIO Output Operating Modes (GPD = 1)

GM(1)	GM(0)	MODE DESCRIPTION
0	0	GPIO = 0
0	1	GPIO = High impedance
1	0	GPIO = 0, ALERT output pulse enabled
1	1	GPIO = High impedance, ALERT output pulse enabled



# Stereo Audio DAC with DirectDrive Headphone Amplifier

**Table 4. Interrupt Enable Register (0x4) Events**

EVENT	BIT NUMBER IN REGISTER 0x4
LCK (register 0x0, bit B5) sets when the internal PLL acquires or loses frequency lock	B5
SHPS (register 0x0, bit B4) sets after the headphone is inserted and the debounce time has elapsed when the headphone amplifier is powered up and ready	B4
VMN (register 0x0, bit B3) sets when the headphone amplifier minimum volume is reached	B3
IOHL or IOHR (register 0x0, bits B1 or B0) sets after an overcurrent at either HPL or HPR	B0

The interrupt enable register programs the MAX9850 to set ALERT = 1 when an event occurs. GPIO pulses when ALERT sets if GM(1:0) is programmed with 10 or 11. Table 4 contains a list of events that can set ALERT and their corresponding bit positions in the interrupt enable register. Enable the interrupt for each event by setting its bit to 1.

### GPIO as an Input

The state of the GPIO input is read through SGPIO in the status A register (register 0x0, bit B6). Set ISGPIO = 1 to allow ALERT to set when SGPIO changes state.

### Internal Timing

The internal clock (ICLK) and sample rate clock (LRCLK in master mode) are derived from MCLK. The MAX9850's flexible operating modes allow any desired LRCLK sample rate to operate over a wide range of MCLK input frequencies.

Figure 3 shows a flowchart detailing how the internal clocks are derived from MCLK. The MAX9850 generates ICLK by dividing the MCLK frequency. Higher ICLK frequencies allow for greater DAC oversampling and SNR performance. Dynamic range of 90dB (typ) is possible when  $f_{ICLK}$  is greater than or equal to 12MHz. Lower ICLK frequencies may require slightly less supply current but sacrifice dynamic range. See the SNR vs. MCLK Frequency graph in the *Typical Operating Characteristics*.

ICLK is a frequency-scaled version of MCLK that is used by the MAX9850 to clock the internal DAC circuitry and generate LRCLK and BCLK when in master mode. The charge-pump clock is derived from ICLK when the internal charge-pump oscillator is not used.

Connect an available system clock to MCLK, see the *DAC Operating Modes* section. MCLK can be supplied from any synchronous or available asynchronous system clock whose frequency falls within the 8.448MHz to 13MHz, or 16.896MHz to 40MHz range. Any MCLK within these ranges allow the MAX9850 to operate at any sample rate between 8kHz to 48kHz in either a master or slave mode of operation. Other MCLK frequencies can still be used, but will limit the sample rate ranges that the MAX9850 operates with as illustrated in Table 5.

Higher ICLK frequencies provide higher SNR. Always use the highest acceptable ICLK. Sample rates other than those listed in Table 5 can be used. The MAX9850 defaults to IC(1:0) = 0x0 at power-up.

### DAC Operating Modes

Four DAC operating modes: master integer, slave integer, master noninteger, and slave noninteger allow flexibility for operating with various applications and virtually any available MCLK frequency within the system. The operating modes are set with MAS in the digital audio register (register 0xA, bit B7) and INT in the LRCLK MSB register (register 0x8, bit B7). Table 6 shows the four modes of operation and the equations needed to program the MAX9850 to use the DAC modes.

The master and slave integer modes are the modes in which DACs commonly operate. In these modes, LRCLK is ICLK divided by an integer value. A typical application would set MCLK equal to 256 x LRCLK. The MAX9850 requires that ICLK be an integer multiple of 16 x LRCLK where the integer multiple is at least 10 when in master or slave integer modes. Integer mode always provides the maximum full-scale signal level performance compared to other modes of operation. Choose integer mode over any other mode of operation when possible.

The master noninteger mode allows for a condition where LRCLK and ICLK may not be related by an integer value. In these modes, the MAX9850 can operate from any available MCLK in the system.

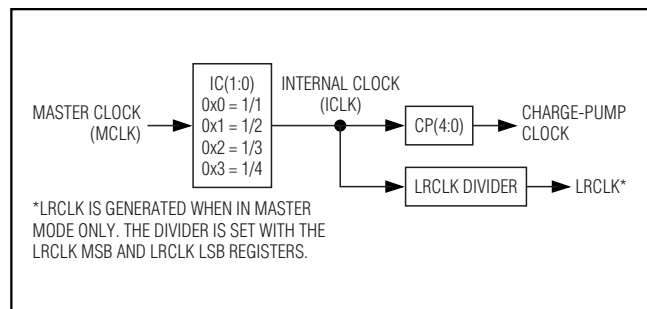

Figure 3. Internally Generated Clock Signals Derived from MCLK

# Stereo Audio DAC with DirectDrive Headphone Amplifier

Table 5. Acceptable MCLK Frequency Ranges

LRCLK (kHz)	MINIMUM ICLK (MHz)		MAXIMUM ICLK (MHz)	ACCEPTABLE MCLK FREQUENCIES* (MHz)			
	INTEGER MODE (160 x f <sub>LRCLK</sub> )	NONINTEGER MODE (176 x f <sub>LRCLK</sub> )	ANY MODE	IC(1:0) = 0x0 SF = 1	IC(1:0) = 0x1 SF = 2	IC(1:0) = 0x2 SF = 3	IC(1:0) = 0x3 SF = 4
8	1.280	1.4080	13.0	1.280 and 1.4080 to 13.0	2.560 and 2.8160 to 26.0	3.840 and 4.2240 to 39.0	5.120 and 5.6320 to 40.0
11.025	1.764	1.9404	13.0	1.764 and 1.9404 to 13.0	3.528 and 3.8808 to 26.0	5.292 and 5.8212 to 39.0	7.056 and 7.7616 to 40.0
12	1.920	2.1120	13.0	1.920 and 2.1120 to 13.0	3.840 and 4.2240 to 26.0	5.760 and 6.3360 to 39.0	7.680 and 8.4480 to 40.0
16	2.560	2.8160	13.0	2.560 and 2.8160 to 13.0	5.120 and 5.6320 to 26.0	7.680 and 8.4480 to 39.0	10.240 and 11.2640 to 40.0
22.05	3.528	3.8808	13.0	3.528 and 3.8808 to 13.0	7.056 and 7.7616 to 26.0	10.584 and 11.6424 to 39.0	14.112 and 15.5232 to 40.0
24	3.840	4.2240	13.0	3.840 and 4.2240 to 13.0	7.680 and 8.4480 to 26.0	11.520 and 12.6720 to 39.0	15.360 and 16.8960 to 40.0
32	5.120	5.6320	13.0	5.120 and 5.6320 to 13.0	10.240 and 11.2640 to 26.0	15.360 and 16.8960 to 39.0	20.480 and 22.5280 to 40.0
44.1	7.056	7.7616	13.0	7.056 and 7.7616 to 13.0	14.112 and 15.5232 to 26.0	21.168 and 23.2848 to 39.0	28.224 and 31.0464 to 40.0
48	7.680	8.4480	13.0	7.680 and 8.4480 to 13.0	15.360 and 16.8960 to 26.0	23.040 and 25.3440 to 39.0	30.720 and 33.7920 to 40.0

\*The first frequency listed is the minimum MCLK frequency required to operate in integer mode. The range of frequencies indicates the MCLK frequencies the MAX9850 needs to operate in any mode.

Table 6. DAC Operating Modes

MODE	SLAVE MODE (MAS = 0) <i>LRCLK and BCLK signals supplied from external source</i>	MASTER MODE (MAS = 1) <i>LRCLK and BCLK signals supplied by MAX9850</i>
<b>NONINTEGER MODE (INT = 0)</b> <i>LRCLK may be any frequency within an acceptable range</i>	Asynchronous $N_{MSB,LSB} = 0$	Asynchronous $N_{MSB,LSB} = \frac{2^{22} \times f_{LRCLK}}{f_{ICLK}}$
<b>INTEGER MODE (INT = 1)</b> <i>ICLK and LRCLK must be synchronous and exact integer ratio related</i>	Synchronous $N_{LSB} = \frac{f_{ICLK}}{16 \times f_{LRCLK}}, N_{MSB} = 0$	

# Stereo Audio DAC with DirectDrive Headphone Amplifier

Slave modes of operation allow the MAX9850 to operate in any audio system where the LRCLK and BCLK must be supplied from an external source. When operating in slave mode, the MCLK supplied to the MAX9850 may be either synchronous or asynchronous with LRCLK. Use the slave integer mode if ICLK is synchronous and has an integer multiple of 16 x LRCLK. Integer mode ensures that the highest levels of full-scale-input signal performance can be achieved. Slave noninteger mode offers the highest degree of clock flexibility. ICLK does not need to be synchronous or an integer multiple of LRCLK when operating in slave noninteger mode.

Master modes of operation allow the MAX9850 to generate and supply an LRCLK and BCLK to other elements in the system. Use master integer mode if the provided ICLK is an integer multiple of 16 x LRCLK. Integer mode ensures that the highest levels of full-scale input signal performance can be achieved. Master noninteger mode allows the MAX9850 to supply virtually any frequency LRCLK with an accuracy better than  $\pm 0.5\%$ .

The slave noninteger mode provides maximum flexibility for ICLK and LRCLK frequencies. The ICLK and LRCLK can be asynchronous and noninteger related. Connect any available system clock that is listed on Table 5 in the *Internal Timing* section. In slave noninteger mode, the acceptable MCLK frequency range is the same as master mode.

## Master Integer Mode (MAS = 1, IM = 1)

The MAX9850 generates the LRCLK and BCLK in master mode. LRCLK is an integer factor of ICLK by the following equation:

$$f_{LRCLK} = \frac{f_{ICLK}}{16 \times N_{LSB}}$$

where:

$f_{ICLK}$  = ICLK frequency.  $f_{ICLK}$  must be at least 160 x  $f_{LRCLK}$  for proper DAC operation.

$N_{LSB}$  = decimal value of the data contained in LSB(7:0) (register 0x9, bits B7–B0).

$f_{LRCLK}$  = LRCLK frequency.

For example:

$f_{ICLK} = 12.228\text{MHz}$  and  $N_{LSB} = 16$  (0x10),  $f_{LRCLK} = 48\text{kHz}$ .

Solve the above equation for  $N_{LSB}$ . Use master integer mode if  $N_{LSB}$  is an integer. Use master noninteger mode if  $N_{LSB}$  is not an integer.

## Slave Integer Mode (MAS = 0, IM = 1)

The MAX9850 accepts LRCLK and BCLK from an external digital audio source when in slave integer mode. LRCLK must be an **exact** integer multiple of ICLK to ensure proper operation. Program LSB(7:0) (register 0x9, bits B7–B0) with the LRCLK division ratio. Use the following equation to find the value that needs to be programmed to LSB(7:0):

$$N_{LSB} = \frac{f_{ICLK}}{16 \times f_{LRCLK}}$$

where:

$f_{ICLK}$  = ICLK frequency.  $f_{ICLK}$  must be 160 x  $f_{LRCLK}$  for proper DAC operation.

$f_{LRCLK}$  = supplied LRCLK frequency.

$N_{LSB}$  = decimal value of the data contained in LSB(7:0) (register 0x9, bits B7–B0).

For example:

$f_{ICLK} = 11.2896\text{MHz}$  and  $f_{LRCLK} = 44.1\text{kHz}$ ,  $N_{LSB} = 16$  (0x10).

Solve the above equation for  $N_{LSB}$ . Use slave integer mode if  $N_{LSB}$  is an integer. Use slave noninteger mode if  $N_{LSB}$  is not an integer.

## Slave Noninteger Mode (MAS = 0, IM = 0)

In slave noninteger mode, the MAX9850 accepts an external LRCLK and converts the digital audio signal using any asynchronous ICLK within the acceptable operating range. The MAX9850 uses internal clock recovery circuitry to generate all required internal clocks. This allows the MAX9850 to operate in systems that do not have dedicated clock sources or crystal oscillators. Virtually any existing system clock will work.  $f_{ICLK}$  must be at least 176 x  $f_{LRCLK}$  for proper operation.

## Master Noninteger Mode (MAS = 1, IM = 0)

The ICLK frequency in some applications may not be an integer multiple of the desired LRCLK frequency. The MAX9850, operating in master noninteger mode, can generate and output any LRCLK frequency between 8kHz to 48kHz ( $\pm 0.5\%$ ) with any ICLK frequency within the acceptable operating range. In this mode, the MAX9850 generates LRCLK by dividing MCLK by the ratio programmed into MSB(14:8) and LSB(7:0) (register 0x8, bits B7–B0 and register 0x9, bits B6–B0). The LRCLK sample frequency can have any noninteger relationship with respect to MCLK. Calculate the values for MSB(14:8) and LSB(7:0) with the following equation:

$$N_{MSB,LSB} = \text{ROUND} \left( \frac{2^{22} \times f_{LRCLK}}{f_{ICLK}} \right)$$

# Stereo Audio DAC with DirectDrive Headphone Amplifier

where:

$f_{\text{ICLK}}$  = ICLK frequency.  $f_{\text{ICLK}}$  must be at least  $176 \times f_{\text{LRCLK}}$  for proper DAC operation.

$f_{\text{LRCLK}}$  = LRCLK frequency.

$N_{\text{MSB,LSB}}$  = decimal value of MSB(14:8) and LSB(7:0) (register 0x8, bits B6–B0 and register 0x9, bits B7–B0).

Round the results of the equation to the nearest integer value.

For example:

$f_{\text{LRCLK}} = 44.1\text{kHz}$ ,  $f_{\text{ICLK}} = 12.288\text{MHz}$ .

- 1) Solve for  $N_{\text{MSB,LSB}}$ , 15052.8.
- 2) Round result to nearest integer value. 15053.
- 3) Convert to hex, 0x3CD.
- 4) Program MSB(14:8) with the MSB 0x3A and program LSB(7:0) with the LSB 0xCD.

Table 7 provides examples of using master noninteger mode with various MCLK frequencies to generate useful LRCLK frequencies.

## Charge Pump

The DirectDrive line and headphone outputs of the MAX9850 require a charge pump to create the internal negative power supply. Set CPEN(1:0) = 11 in the enable register (register 0x5, bits B5 and B4) to turn on the charge pump. The negative charge-pump voltage is established and the audio outputs are ready for use approximately 1.4ms after CPEN is set to 11.

The state of CP(4:0), in the charge-pump register (register 0x7, bits B4–B0), determines whether the charge-pump oscillator is derived from the internal 667kHz oscillator or from MCLK. Set CPEN(1:0) = 11 and set CP(4:0) = 0x00 to enable the internal oscillator. The charge pump runs independent from MCLK when the internal oscillator is enabled allowing the charge pump to operate when the DAC is disabled or when only the line inputs are used. No MCLK is required when only the line inputs are used.

The switching frequency of the charge pump is well beyond the audio range and does not interfere with audio signals. The switch drivers utilize techniques that minimize noise generated by turn-on and turn-off transients. Although not typically required, additional high-frequency noise attenuation can be achieved by increasing the size of C2 and the PVDD bypass capacitor (see the *Functional Diagram/Typical Operating Circuit*).

Derive the charge-pump clock from MCLK by programming CP(4:0) to a non-zero value based on the following equation:

$$N_{\text{CP}(4:0)} = \frac{f_{\text{MCLK}}}{2 \times f_{\text{CP}} \times \text{SF}}$$

where:

$f_{\text{MCLK}}$  = MCLK frequency.

$f_{\text{CP}}$  = charge-pump clock frequency. Ensure  $f_{\text{CP}} = 667\text{kHz} \pm 20\%$  for proper operation.

SF = MCLK scale factor. SF is the decimal value of IC(1:0) + 1.

$N_{\text{CP}(4:0)}$  = rounded decimal value of CP(4:0) (register 0x7, bits B4–B0).  $N_{\text{CP}(4:0)}$  must be greater than 1 when deriving the charge-pump clock from ICLK.

**Table 7. Master Noninteger NMSB,LSB Examples**

MCLK (MHz)	SF	ICLK (MHz)	N (15-BIT hex VALUE)									
			LRCLK OUTPUT FREQUENCY (kHz)									
			48	44.1	32	24	22.05	16	12	11.03	8	
18.4320	2	9.2160	5555	4E66	38E4	2AAB	2733	1C72	1555	139A	0E39	
16.9344	2	8.4672	5CE1	5555	3DEB	2E71	2AAB	1EF6	1738	1555	0F7B	
16.3840	2	8.1920		5833	<b>4000</b>	3000	2C1A	<b>2000</b>	1800	160D	1000	
12.5000	1	12.5000	3EEA	39CE	29F1	1F75	1CE7	14F9	0FBF	0E73	0A7C	
12.2880	1	12.2880	<b>4000</b>	3ACD	2AAB	<b>2000</b>	1D66	1555	<b>1000</b>	0EB3	0AAB	
12.0000	1	12.0000	4189	3C36	2BB1	20C5	1E1B	15D8	1062	0F0E	0AEC	
11.2896	1	11.2896	45A9	<b>4000</b>	2E71	22D4	<b>2000</b>	1738	116A	<b>1000</b>	0B9C	
9.2160	1	9.2160	5555	4E66	38E4	2AAB	2733	1C72	1555	139A	0E39	
8.4672	1	8.4672	5CE1	5555	3DEB	2E71	2AAB	1EF6	1738	1555	0F7B	
8.4480	1	8.4480	5D17	5587	3E10	2E8C	2AC3	1F08	1746	1562	0F84	

**Note:** The N values represent the combined MSB(14:8) and LSB(7:0) values.

# Stereo Audio DAC with DirectDrive Headphone Amplifier

**MAX9850**

For example:

$f_{MCLK} = 12\text{MHz}$ ,  $SF = 1$ , and  $f_{CP} = 666.7\text{kHz}$ ,  $N_{CP(4:0)} = 9$ .

Table 8 shows recommended CP(4:0) values for typical MCLK frequencies.

**Table 8. Recommended CP(4:0) Values for Typical MCLK Frequencies**

f <sub>MCLK</sub> (MHz)	CP(4:0)	IC(1:0)	SF	f <sub>CP</sub> (kHz)
11.2896	0x08	0x0	1	705.6
12.0000	0x09	0x0	1	666.7
12.2880	0x09	0x0	1	682.7
13.0000	0x0A	0x0	1	650.0
24.0000	0x09	0x1	2	666.7
27.0000	0x07	0x2	3	642.9

## Registers and Bit Descriptions

Eleven internal registers program and report the status of the MAX9850. Table 9 lists all of the registers, their addresses, and power-on-reset state. Registers 0x0 and 0x1 are read-only while all of the other registers are read/write. Register 0xB is reserved for factory testing.

**Table 9. Register Map**

REGISTER	B7	B6	B5	B4	B3	B2	B1	B0	REGISTER ADDRESS	POWER-ON RESET STATE	
Status A	ALERT	SGPIO	LCK	SHPS	VMN	1	IOHL	IOHR	0x0	—	
Status B	X	X	X	SMONO	SHP	SLO	SLI	SDAC	0x1	—	
Volume	MUTE	SLEW	VOL(5:0)							0x2	0x0C
General Purpose	GM(1:0)		GPD	DBDEL(1:0)		MONO	0	ZDEN	0x3	0x00	
Interrupt Enable	0	ISGPIO	ILCK	ISHPS	IVMN	0	0	IIOH	0x4	0x00	
Enable	SHDN	MCLKEN	CPEN(1:0)		HPEN	LNOEN	LNIEN	DACEN	0x5	0x00	
Clock	0	0	0	0	IC(1:0)		0	0	0x6	0x00	
Charge Pump	SR(1:0)		0	CP(4:0)					0x7	0x00	
LRCLK MSB	INT	MSB(14:8)							0x8	0x00	
LRCLK LSB	LSB(7:0)							0x9	0x00		
Digital Audio	MAS	INV	BCINV	LSF	DLY	RTJ	WS(1:0)		0xA	0x00	
RESERVED									0xB	—	

X = Don't Care.

# Stereo Audio DAC with DirectDrive Headphone Amplifier

## Status Registers (0x0, 0x1)

**Table 10. Status A (0x0) Read-Only, Bit Descriptions**

B7	B6	B5	B4	B3	B2	B1	B0
ALERT	SGPIO	LCK	SHPS	VMN	1	IOHL	IOHR

### Alert Flag (ALERT)

1 = An interrupt event has occurred.

0 = No interrupt event has occurred.

ALERT is an alert flag that sets when an interrupt event has occurred. The events that can be programmed to set ALERT are as follows:

- A change in state on SGPIO indicating a change in levels at GPIO when GPIO is configured as an input. Configure GPIO as an input and set ISGPIO = 1 in the interrupt enable register (register 0x4, bit B6).
- The internal PLL locks or unlocks with LRCLK. Set ILCK = 1 in the interrupt enable register (register 0x4, bit B5).
- A change in state on SHPS indicating headphones have been connected or disconnected. Set ISHPS = 1 in the interrupt enable register (register 0x4, bit B4).
- The headphone amplifier reaches its minimum volume. Set IVMN = 1 in the interrupt enable register (register 0x4, bit B3).
- An overload on either right or left headphone outputs (HPR, HPL). Set IIOH = 1 in the interrupt enable register (register 0x4, bit B0).

ALERT sets to 1 after an event occurs and remains set until the status A register is read. GPIO configured as an output can interrupt a  $\mu$ C on an ALERT event. GM(1:0) in the GPIO register (register 0x3, bits B7 and B6) control the output mode of GPIO. See the *GPIO* section for more information on programming GPIO as an output.

### GPIO Status (SGPIO)

1 = GPIO is high.

0 = GPIO is low.

SGPIO reports the status of GPIO at the time that status A is read, regardless of whether GPIO is programmed as an input or output. A change in state on SGPIO causes ALERT to set to 1 when GPIO is configured as an input and ISGPIO = 1 in the interrupt enable register (register 0x4, bit B6).

### PLL Lock Status (LCK)

1 = The internal PLL is locked with LRCLK.

0 = The internal PLL is not locked with LRCLK.

LCK reports the lock status of the internal PLL at the time that STATUS A is read. The DAC is disabled when the PLL is not locked. When the PLL is locked with LRCLK, the DAC will become operational if DACEN is equal to 1 (register 0x5, bit B0). ALERT sets to 1 when LCK changes state if ILCK = 1 in the interrupt enable register (register 0x4, bit B5).

### HPS Status (SHPS)

1 = HPS is high, indicating that headphones are connected.

0 = HPS is low, indicating no headphone is connected.

SHPS reports the debounced status of HPS at the time STATUS A is read. SHPS = 0 indicates that no headphone is connected and HPS is low. SHPS sets to 1 when HPS is high, indicating headphones are connected. ALERT sets to 1 when SHPS changes state, if ISHPS = 1 in the interrupt enable register (register 0x4, bit B4).

### Volume at Minimum (VMN)

1 = Headphone volume has reached its minimum volume.

0 = Headphone volume is not at its minimum.

VMN sets to 1 when the minimum headphone amplifier volume has been reached. ALERT sets to 1 when IVMN = 1 in the interrupt enable register (register 0x4, bit B3).

### Headphone Overcurrent Left (IOHL)

1 = The left headphone output (HPL) has experienced an overcurrent condition.

0 = The left headphone output (HPL) is operating normally.

IOHL sets to 1, when an overcurrent occurs on the left headphone output HPL and remains set until status A is read. ALERT sets to 1 when an overcurrent on the right or left headphone output occurs if IIOH = 1 in the interrupt enable register (register 0x4, bit B0).

### Headphone Overcurrent Right (IOHR)

1 = The right headphone output (HPR) has experienced an overcurrent condition.

0 = The right headphone output (HPR) is operating normally.

IOHR sets to 1 and remains set until STATUS A is read. ALERT sets to 1 when an overcurrent on the right or left headphone output occurs if IIOH = 1 in the interrupt enable register (register 0x4, bit B0).

# Stereo Audio DAC with DirectDrive Headphone Amplifier

**Table 11. Status B (0x1) Read-Only, Bit Descriptions**

B7	B6	B5	B4	B3	B2	B1	B0
X	X	X	SMONO	SHP	SLO	SLI	SDAC

***Mono Status (SMONO)***

1 = The headphone amplifier outputs are in mono mode.

0 = The headphone amplifier outputs are in stereo mode.

SMONO indicates whether the headphone outputs are in mono or stereo mode. In mono mode, the left and right audio signals are mixed and output to the left headphone output. Set MONO = 1 in the general-purpose register (register 0x3, bit B2) to enter mono mode.

***Headphone Amplifier Status (SHP)***

0 = The headphone amplifiers are operating.

1 = The headphone amplifiers are not operating.

SHP indicates whether the headphone amplifiers are operating or not operating.

***Line Output Status (SLO)***

0 = The line outputs are enabled.

1 = The line outputs are disabled.

SLO indicates whether the line outputs are enabled or disabled. Set LNOEN = 1 in the enable register (register 0x5, bit B2) to enable the line outputs.

***Line Input Status (SLI)***

0 = The line inputs are enabled.

1 = The line inputs are disabled.

SLI indicates whether the line inputs are enabled or disabled. Set LNIEN = 1 in the enable register (register 0x5, bit B1) to enable the line inputs.

***DAC Status (SDAC)***

0 = The DAC is operating and has completed a soft-start sequence.

1 = The DAC is not operating and has completed a soft-stop sequence.

SDAC indicates whether the DAC is operational and receiving valid clock signals, or not operating.

# Stereo Audio DAC with DirectDrive Headphone Amplifier

## Volume Register (0x2)

**Table 12. Volume (0x2) Read/Write, Bit Descriptions**

B7	B6	B5	B4	B3	B2	B1	B0
MUTE	SLEW	VOL(5:0)					

### Mute Enable (MUTE)

1 = Mute headphone outputs.

0 = Unmute headphone outputs.

Set MUTE = 1 to mute the headphone outputs (HPR, HPL). The headphone output is muted on the first zero crossing of the audio signal if zero-crossing detect is enabled.

**Table 13. Volume Control Settings**

VOL(5:0)	SETTING (dB)
0x00	+6.0
0x01	+5.5
0x02	+5.0
0x03	+4.5
0x04	+4.0
0x05	+3.5
0x06	+3.0
0x07	+2.5
0x08	+1.5
0x09	+0.5
0x0A	-0.5
0x0B	-1.5
0x0C	-3.5
0x0D	-5.5

VOL(5:0)	SETTING (dB)
0x0E	-7.5
0x0F	-9.5
0x10	-11.5
0x11	-13.5
0x12	-15.5
0x13	-17.5
0x14	-19.5
0x15	-21.5
0x16	-23.5
0x17	-25.5
0x18	-27.5
0x19	-29.5
0x1A	-31.5
0x1B	-33.5

VOL(5:0)	SETTING (dB)
0x1C	-35.5
0x1D	-37.5
0x1E	-39.5
0x1F	-41.5
0x20	-45.5
0x21	-49.5
0x22	-53.5
0x23	-57.5
0x24	-61.5
0x25	-65.5
0x26	-69.5
0x27	-73.5
0x28-0x3F	Mute
—	—

## Slew-Rate Control Enable (SLEW)

1 = Enable slew-rate control.

0 = Disable slew-rate control.

The slew-rate control allows the headphone amplifiers to smoothly slew between volume settings after a volume change is made. Volume changes occur immediately when the slew-rate control is disabled.

## Volume Control (VOL(5:0))

VOL(5:0) controls the headphone amplifier volume attenuation. Code 0x00 is full volume while 0x28 to 0x3F is full attenuation. VMN sets to 1 when code 0x3F is programmed and the minimum volume is reached. Table 13 lists the volume attenuation settings for each code.



# Stereo Audio DAC with DirectDrive Headphone Amplifier

MAX9850

## General-Purpose Register

**Table 14. General Purpose (0x3)  
Read/Write, Bit Descriptions**

B7	B6	B5	B4	B3	B2	B1	B0
GM(1:0)		GPD	DBDEL(1:0)		MONO	0	ZDEN

### GPIO Output Mode Control (GM(1:0))

00 = GPIO outputs low.

01 = GPIO is high impedance.

10 = GPIO outputs low and the ALERT output pulse function is enabled.

11 = GPIO is high impedance and the ALERT output pulse function is enabled.

GM(1:0) programs the GPIO output state and enables or disables the ALERT output pulse function. The open-drain GPIO output can be programmed to output static high or a low. GPIO can also be programmed to pulse to the opposite output level than the programmed output state when an alert occurs. An alert occurs when ALERT sets to 1 in the status A register. GM(1:0) has no function when GPIO is configured as an input.

### GPIO Direction (GPD)

1 = Configure GPIO as an open-drain output.

0 = Configure GPIO as an input.

The state of GPD determines whether GPIO is an input or an output.

### Debounce Delay Control (DBDEL(1:0))

00 = HPS debounce delay disabled.

01 = HPS debounce delay is a nominal 200ms.

10 = HPS debounce delay is a nominal 400ms.

11 = HPS debounce delay is a nominal 800ms.

DBDEL(1:0) controls the length of HPS debounce time. The debounce time is derived from the charge-pump clock.

### Mono Mode Enable (MONO)

1 = Enable mono mode.

0 = Disable mono mode, headphone outputs in stereo mode.

Set MONO = 1 to force the headphone outputs to mono mode. The stereo input signal is summed to one channel. The summed signal is output on the left headphone output (HPL).

### Zero-Detect Enable (ZDEN)

1 = Enables the zero-detect function.

0 = Disables the zero-detect function.

Volume changes, headphone output muting, and entering/exiting shutdown occur only on the zero crossing of the audio signal when ZDEN = 1. For optimum performance, set SR(1:0) to 01.

## Interrupt Enable Register

**Table 15. Interrupt Enable (0x4)  
Read/Write, Bit Descriptions**

B7	B6	B5	B4	B3	B2	B1	B0
0	ISGPIO	ILCK	ISHPS	IVMN	0	0	IIOH

**Note:** Any of the below interrupts can be configured to trigger a hardware interrupt through GPIO. Program GPD and GM(1:0) in the general-purpose register to enable the ALERT output pulse function.

### SGPIO Interrupt Enable (ISGPIO)

1 = A state change on SGPIO, when GPIO is an input, will cause ALERT to set to 1.

0 = A state change on SGPIO, when GPIO is an input, will not cause ALERT to set.

ISGPIO = 1 configures the MAX9850 to set ALERT = 1 when SGPIO changes state. The interrupt may only be enabled when GPIO is an input.

### PLL Lock Interrupt Enable (ILCK)

1 = A state change on LCK will cause ALERT to set to 1.

0 = A state change on LCK will not cause ALERT to set.

ILCK = 1 configures the MAX9850 to set ALERT = 1 when the DAC's internal PLL loses or achieves frequency lock with LRCLK. Program GM(1:0), while GPD = 1, to configure GPIO as a hardware interrupt to alert a  $\mu$ C when LCK changes state.

### SHPS Interrupt Enable (ISHPS)

1 = A state change on SHPS will cause ALERT to set to 1.

0 = A state change on SHPS will not cause ALERT to set.

ISHPS = 1 configures the MAX9850 to set ALERT = 1 when SHPS changes state.

### Volume at Minimum Interrupt Enable (IVMN)

1 = A state change on VMN will cause ALERT to set to 1.

0 = A state change on VMN will not cause ALERT to set.

IVMN = 1 configures the MAX9850 to set ALERT = 1 when the headphone amplifier is programmed to and reaches its minimum output volume. Program GM(1:0), while GPD = 1, to configure GPIO as a hardware interrupt to alert a  $\mu$ C when the headphone output volume is programmed to and reaches its minimum volume.

# Stereo Audio DAC with DirectDrive Headphone Amplifier

## Headphone Overcurrent Interrupt Enable (IIOH)

1 = ALERT sets to 1 when either IOHL or IOHR set to 1.

0 = ALERT will not set when IOHL or IOHR set to 1.

IIOH = 1 configures the MAX9850 to set ALERT = 1 when one or both of the headphone amplifier outputs (HPL, HPR) has experienced an overcurrent condition. Program GM(1:0), while GPD = 1, to configure GPIO as a hardware interrupt to alert a  $\mu$ C to an overcurrent condition on the headphone outputs.

## Enable Register

**Table 16. Enable (0x5) Read/Write, Bit Descriptions**

B7	B6	B5	B4	B3	B2	B1	B0
SHDN	MCLKEN	CPEN (1:0)	HPEN	LNOEN	LNIEEN	DACEN	

## Shutdown ( $\overline{\text{SHDN}}$ )

1 = The MAX9850 is powered on.

0 = The MAX9850 is in low-power shutdown mode. The I<sup>2</sup>C interface remains active.

Set  $\overline{\text{SHDN}}$  = 1 to power on the MAX9850. The headphone amplifier, master clock, line inputs/outputs, DAC, charge pump, and charge-pump clock all have their own enable bits. The individual components of the MAX9850 can only be enabled after  $\overline{\text{SHDN}}$  = 1.

## MCLK Enable (MCLKEN)

1 = MCLK is connected to the MAX9850.

0 = MCLK is disconnected from the MAX9850.

MCLKEN must be set to 1 for the DAC to operate properly. The line inputs/outputs and headphone amplifiers will work if MCLKEN = 0, but the charge-pump clock must be derived from the internal oscillator.

## Charge-Pump Enable (CPEN(1:0))

11 = Enable the internal charge pump.

00 = Disable the internal charge pump.

10 and 01 = Invalid.

Set CPEN(1:0) to 11 to enable the internal charge pump when the line outputs and headphone amplifiers are used.

## Headphone Output Enable (HPEN)

1 = Enable the headphone outputs.

0 = Disable the headphone outputs.

Set HPEN = 1 to enable the headphone outputs. HPEN = 0 places the headphone outputs in high impedance. The line outputs must be enabled for the headphone amplifiers to operate properly.

## Line Output Enable (LNOEN)

1 = Enable the line outputs.

0 = Disable the line outputs.

LNOEN = 0 forces the line outputs and the headphone outputs to high impedance. Set LNOEN = 1 to enable the line outputs. The line outputs must be enabled for the headphone amplifiers to operate properly.

## Line Input Enable (LNIEEN)

1 = Enable the line inputs.

0 = Disable the line inputs.

LNIEEN = 1 enables the line inputs. LNIEEN = 0 disconnects the line inputs.

## DAC Enable (DACEN)

1 = Enable the audio DAC.

0 = Disable the audio DAC.

DACEN = 1 enables the DAC and all supporting circuitry including the digital audio interface and interpolating FIR filter. DACEN = 0 places the DAC and support circuitry into low-power shutdown mode.

## Clock Register

**Table 17. Clock (0x6) Read/Write, Bit Descriptions**

B7	B6	B5	B4	B3	B2	B1	B0
0	0	0	0	IC(1:0)	0	0	0

## Internal Clock Divide (IC(1:0))

00 = Internal clock divider is transparent ( $f_{\text{CLK}} = f_{\text{MCLK}}$ ).

01 = ( $f_{\text{CLK}} = f_{\text{MCLK}} / 2$ ).

10 = ( $f_{\text{CLK}} = f_{\text{MCLK}} / 3$ ).

11 = ( $f_{\text{CLK}} = f_{\text{MCLK}} / 4$ ).

IC(1:0) controls the internal clock divider that determines the internal clock frequency from the master clock.

## Charge-Pump Register

**Table 18. Charge Pump (0x7) Read/Write, Bit Descriptions**

B7	B6	B5	B4	B3	B2	B1	B0
SR(1:0)		0	CP(4:0)				

# Stereo Audio DAC with DirectDrive Headphone Amplifier

### Slew-Rate Control (SR(1:0))

- 00 = Headphone volume slews from code 0x00 to 0x28 in 63µs. Not recommended when ZDEN = 1.
- 01 = Headphone volume slews from code 0x00 to 0x28 in 125ms.
- 10 = Headphone volume slews from code 0x00 to 0x28 in 63ms.
- 11 = Headphone volume slews from code 0x00 to 0x28 in 42ms.

Program SR(1:0) to set the rate that the MAX9850 uses to slew between two volume settings. The slew-rate control also controls the amount of time the headphone outputs take to mute or shut down after the command is given.

### Charge-Pump Clock Divider (CP(4:0))

CP(4:0) controls the charge-pump clock divider. The charge-pump clock frequency (f<sub>CPCLK</sub>) is derived from either ICLK or from the internal oscillator.

Program CP(4:0) = 0x00 to enable the 667kHz internal oscillator. This allows the headphone amplifiers and line outputs to operate when the DAC is disabled.

Programming CP(4:0) to any value other than 0x00 disables the internal oscillator and derives the charge-pump clock from ICLK. Program CP(4:0) with a value that creates a 667kHz ±20% charge-pump clock from ICLK by the following equation:

$$f_{CP} = \frac{f_{MCLK}}{2 \times N_{CP(4:0)} \times SF}$$

where:

f<sub>MCLK</sub> = MCLK frequency.

N<sub>CP(4:0)</sub> = decimal value of CP(4:0). N<sub>CP(4:0)</sub> must be greater than 1 when deriving the charge-pump clock from ICLK.

f<sub>CP</sub> = charge-pump clock frequency. Program f<sub>CP</sub> = 667kHz ±20% for proper operation.

SF = MCLK scale factor. SF is the decimal value of IC(1:0) + 1.

### LRCLK MSB and LRCLK LSB Registers

**Table 19. LRCLK MSB (0x8) and LRCLK LSB (0x9) Read/Write, Bit Descriptions**

B7	B6	B5	B4	B3	B2	B1	B0
INT	MSB(14:8)						
	LSB(7:0)						

### Integer Mode (INT)

- 1 = Configure the MAX9850 to integer mode.
- 0 = Configure the MAX9850 to noninteger mode.

Integer mode operation requires that ICLK is an integer multiple of 16 times the sample rate (f<sub>LRCLK</sub>). See the *DAC Operating Modes* section. When in integer mode, f<sub>LRCLK</sub> = f<sub>ICLK</sub> / (16 × LSB(7:0)).

### LRCLK MSB Divider (MSB(14:8))

MSB(14:8) and LSB(7:0) are used to determine f<sub>LRCLK</sub> when in noninteger mode only (see the *DAC Operating Modes* section). For noninteger mode:

$$N_{MSB,LSB} = \frac{2^{22} \times f_{LRCLK}}{f_{ICLK}}$$

### LRCLK LSB Divider (LSB(7:0))

LSB(7:0) combined with MSB(14:8) sets the LRCLK divider when the MAX9850 is configured in noninteger mode. Only LSB(7:0) is used to determine f<sub>LRCLK</sub> when the MAX9850 is configured in integer mode. See the *DAC Operating Modes* section.

### Digital Audio Register

**Table 20. Digital Audio (0xA) Read/Write, Bit Descriptions**

B7	B6	B5	B4	B3	B2	B1	B0
MAS	INV	BCINV	LSF	DLY	RTJ	WS(1:0)	

### Master Mode (MAS)

- 1 = Configure the MAX9850 to master mode.
- 0 = Configure the MAX9850 to slave mode.

Set MAS = 1 to configure the MAX9850 to master mode. The LRCLK and BCLK are generated by the MAX9850 when in master mode. Set MAS = 0 to configure the MAX9850 as a digital audio slave that accepts LRCLK and BCLK from an external digital audio source.

### LRCLK Invert (INV)

- 1 = Left audio data is clocked in when LRCLK is high and right data is clocked in when LRCLK is low.
  - 0 = Left audio data is clocked in when LRCLK is low and right data is clocked in when LRCLK is high.
- Set INV = 0 to conform to the I<sup>2</sup>S standard.

### Bit Clock Invert (BCINV)

- 1 = Digital data at SDIN latches in on the falling edge of BCLK.
  - 0 = Digital data at SDIN latches in on the rising edge of BCLK.
- Set BCINV = 0 to conform to the I<sup>2</sup>S standard.

# Stereo Audio DAC with DirectDrive Headphone Amplifier

## Least Significant Bit First (LSF)

1 = Accepts audio data LSB first.  
 0 = Accepts audio data MSB first.  
 Set LSF = 0 to conform to the I<sup>2</sup>S standard.

## SDIN Delay (DLY)

1 = Audio data is latched into the MAX9850 on the second rising BCLK edge after LRCLK transitions.  
 0 = Audio data is latched into the MAX9850 on the first rising BCLK edge after LRCLK transitions  
 Set DLY = 1 to conform to the I<sup>2</sup>S standard.

## Right-Justified Data (RTJ)

1 = Audio data is right justified.  
 0 = Audio data is left justified.  
 I<sup>2</sup>S data is left justified. Set RTJ = 0 to conform to the I<sup>2</sup>S standard.

## Word Length Select (WS(1:0))

00 = Audio data word length is 16 bits.  
 01 = Audio data word length is 18 bits.  
 10 = Audio data word length is 20 bits.  
 11 = Audio data word length is 24 bits.  
 Program WS(1:0) to select the input data word length. Programming the audio data word length ensures that the correct number of BCLK cycles are output to accommodate the incoming data word.

## Digital Audio Interface

The MAX9850 receives serial digital audio data through a 3-wire interface. The data can be right or left justified, MSB or LSB first, or I<sup>2</sup>S compatible. The 3-wire serial bus carries two time-multiplexed audio data channels (SDIN), a channel-select line (LRCLK), and a bit clock line (BCLK). The configuration of the audio interface is controlled with the digital audio register, see Table 20. Typical digital audio formats, and the required digital audio register code, are listed in Table 21. Figure 4 illustrates the difference between right justified, left justified, and I<sup>2</sup>S compatible audio data.

**Table 21. Typical Digital Audio Formats**

FORMAT	DIGITAL AUDIO REGISTER CODE (0xA)
Left-Justified Audio Data	X0000000
Right-Justified Audio Data	X0000100
I <sup>2</sup> S-Compatible Audio Data	X0001000

The MAX9850 generates the BCLK and the LRCLK from ICLK when in master mode, see the *Internal Timing* section. In slave mode, the MAX9850 accepts an LRCLK and BCLK from an external digital audio source.

The MAX9850 can accept right- or left-justified data when operating in slave mode with extra BCLK pulses beyond what is programmed by the WS(1:0) bits. When using the I<sup>2</sup>S standard, audio data MSBit must latch into SDIN on the second BCLK rising edge following an LRCLK transition. See Figure 4 for the various relationships between clock and data that are supported by the MAX9850.

The MAX9850 can be configured to accept 16, 18, 20, or 24-bit data. The MAX9850 generates exactly the programmed number of BCLK cycles when in master mode. Program the audio data word size with WS(1:0) (register 0xA, bit B0 and B1) according to Table 22 to ensure that the MAX9850 outputs the correct number of BCLK cycles to accommodate the input word.

**Table 22. Audio Data Word Size**

WS(1:0)	DATA WORD SIZE (BITS)
0x0	16
0x1	18
0x2	20
0x3	24

The internal digital processing resolution is 18 bits wide. Data words longer than 18 bits will be truncated. Zeros are internally programmed into the missing bit positions when the data word is shorter than the programmed word size.

## I<sup>2</sup>C-Compatible Serial Interface

The MAX9850 features an I<sup>2</sup>C/SMBus™-compatible, 2-wire serial interface consisting of a serial data line (SDA) and a serial clock line (SCL). SDA and SCL facilitate communication between the MAX9850 and the master at clock rates up to 400kHz. Figure 5 shows the 2-wire interface timing diagram. The master generates SCL and initiates data transfer on the bus.

A master device writes data to the MAX9850 by transmitting the proper slave address followed by the register address and then the data word. Each transmit sequence is framed by a START (S) or REPEATED START (Sr) condition and a STOP (P) condition. Each word transmitted to the MAX9850 is 8 bits long and is followed by an acknowledge clock pulse.

*SMBus is a trademark of Intel Corp.*

# Stereo Audio DAC with DirectDrive Headphone Amplifier

MAX9850

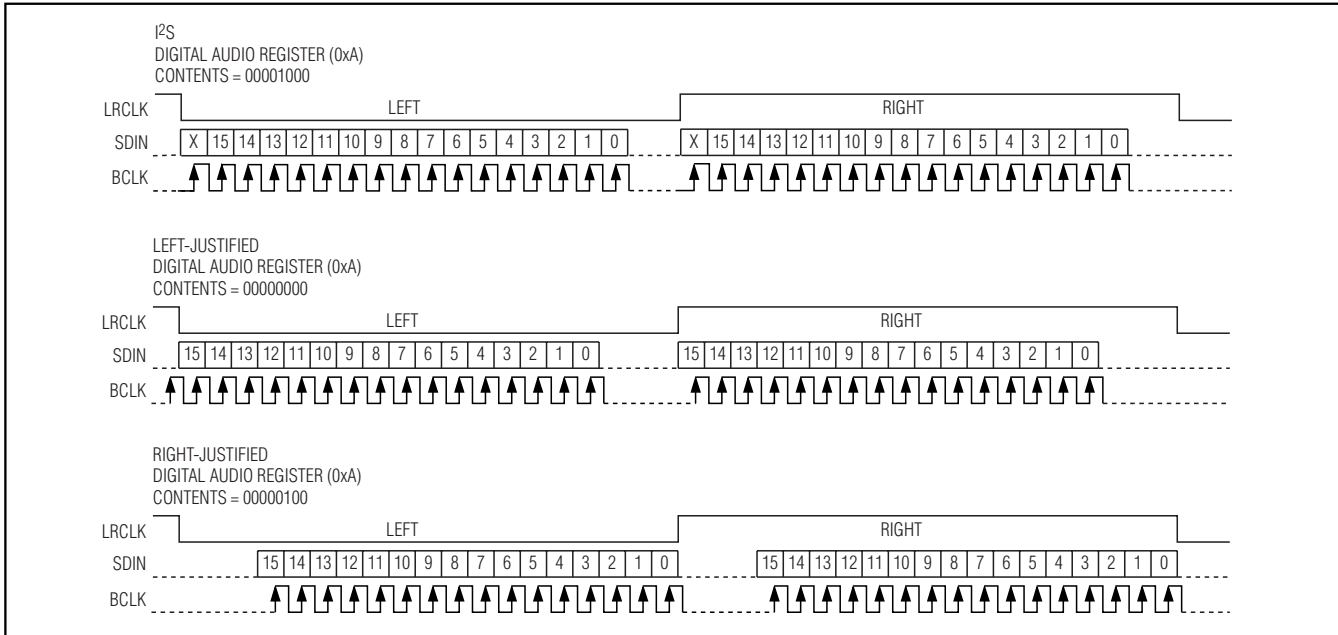

Figure 4. Right-Justified, and Left-Justified Audio Data Formats (Slave Mode, 16-Bit Data)

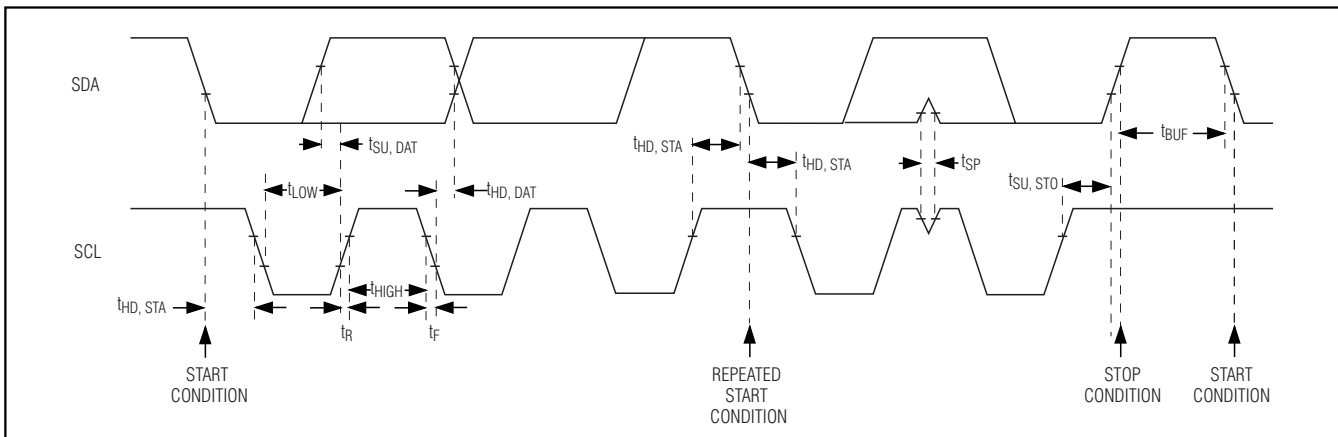

Figure 5. 2-Wire Interface Timing Diagram

A master reading data from the MAX9850 transmits the proper slave address followed by a series of nine SCL pulses. The MAX9850 transmits data on SDA in sync with the master-generated SCL pulses. The master acknowledges receipt of each byte of data. Each read sequence is framed by a START or REPEATED START condition, a not acknowledge, and a STOP condition.

SDA operates as both an input and an open-drain output. A pullup resistor, typically greater than  $500\Omega$ , is required on the SDA bus. SCL operates as an input only. A pullup resistor, typically greater than  $500\Omega$ , is required on SCL if there are multiple masters on the bus, or if the

master in a single-master system has an open-drain SCL output. Series resistors in line with SDA and SCL are optional. Series resistors protect the digital inputs of the MAX9850 from high-voltage spikes on the bus lines, and minimize crosstalk and undershoot of the bus signals.

### Bit Transfer

One data bit is transferred during each SCL cycle. The data on SDA must remain stable during the high period of the SCL pulse. Changes in SDA while SCL is high are control signals (see the *START and STOP Conditions* section). SDA and SCL idle high when the I<sup>2</sup>C bus is not busy.

# Stereo Audio DAC with DirectDrive Headphone Amplifier

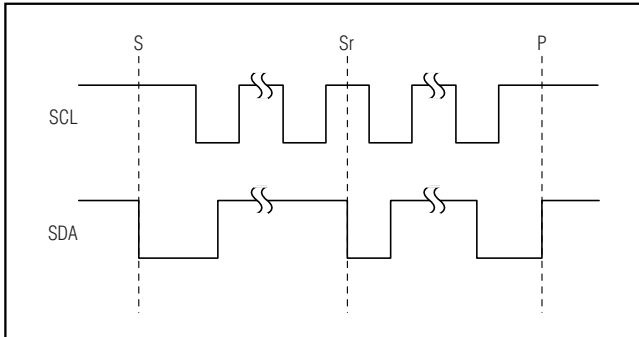

Figure 6. START, STOP, and REPEATED START Conditions

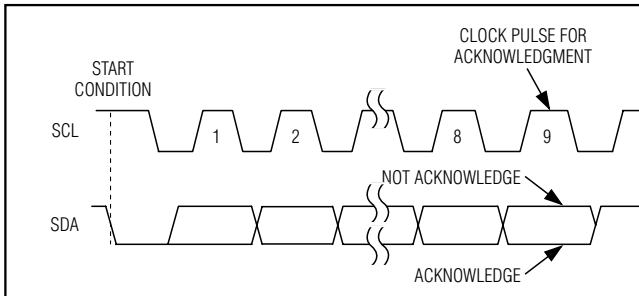

Figure 7. Acknowledge

### Start and Stop Conditions

SDA and SCL idle high when the bus is not in use. A master initiates communication by issuing a START condition. A START condition is a high-to-low transition on SDA with SCL high. A STOP condition is a low-to-high transition on SDA while SCL is high (Figure 6). A START condition from the master signals the beginning of a transmission to the MAX9850. The master terminates transmission, and frees the bus, by issuing a STOP condition. The bus remains active if a REPEATED START condition is generated instead of a STOP condition.

### Early STOP Conditions

The MAX9850 recognizes a STOP condition at any point during data transmission except if the STOP condition occurs in the same high pulse as a START condition. For proper operation, do not send a STOP condition during the same SCL high pulse as the START condition.

Table 23. MAX9850 Address Map

ADD	MAX9850 SLAVE ADDRESS							R/W
	A6	A5	A4	A3	A2	A1	A0	
GND	0	0	1	0	0	0	0	X
AVDD	0	0	1	0	0	0	1	X
SDA	0	0	1	0	0	1	1	X

X = Don't Care.

### Slave Address

The MAX9850 is programmable to one of three slave addresses (see Table 23). These slave addresses are unique device IDs. Connect ADD to GND, AVDD, or SDA to set the I<sup>2</sup>C slave address. The address is defined as the seven most significant bits (MSBs) followed by the Read/Write bit. Set the Read/Write bit to 1 to configure the MAX9850 to read mode. Set the Read/Write bit to 0 to configure the MAX9850 to write mode. The address is the first byte of information sent to the MAX9850 after the START condition.

### Acknowledge

The acknowledge bit (ACK) is a clocked 9th bit that the MAX9850 uses to handshake receipt of each byte of data when in write mode (see Figure 7). The MAX9850 pulls down SDA during the entire master-generated 9th clock pulse if the previous byte is successfully received. Monitoring ACK allows for detection of unsuccessful data transfers. An unsuccessful data transfer occurs if a receiving device is busy or if a system fault has occurred. In the event of an unsuccessful data transfer, the bus master may retry communication.

The master pulls down SDA during the 9th clock cycle to acknowledge receipt of data when the MAX9850 is in read mode. An acknowledge is sent by the master after each read byte to allow data transfer to continue. A not-acknowledge is sent when the master reads the final byte of data from the MAX9850, followed by a STOP condition.

# Stereo Audio DAC with DirectDrive Headphone Amplifier

## Write Data Format

A write to the MAX9850 includes transmission of a START condition, the slave address with the  $\overline{R/\overline{W}}$  bit set to 0 (see Table 23), one byte of data to configure the internal register address pointer, one or more bytes of data, and a STOP condition. Figure 8 illustrates the proper frame format for writing one byte of data to the MAX9850. Figure 9 illustrates the frame format for writing n-bytes of data to the MAX9850.

The slave address with the  $\overline{R/\overline{W}}$  bit set to 0 indicates that the master intends to write data to the MAX9850. The MAX9850 acknowledges receipt of the address byte during the master-generated 9th SCL pulse.

The second byte transmitted from the master configures the MAX9850's internal register address pointer. The pointer tells the MAX9850 where to write the next byte of data. An acknowledge pulse is sent by the MAX9850 upon receipt of the address pointer data.

The third byte sent to the MAX9850 contains the data that will be written to the chosen register. An acknowledge pulse from the MAX9850 signals receipt of the data byte. The address pointer autoincrements to the next register address after each received data byte. This autoincrement feature allows a master to write to

sequential registers within one continuous frame. Figure 9 illustrates how to write to multiple registers with one frame. The master signals the end of transmission by issuing a STOP condition.

Register addresses greater than 0xA are reserved. Do not write to these addresses.

## Read Data Format

Send the slave address with the  $\overline{R/\overline{W}}$  bit set to 1 to initiate a read operation. The MAX9850 acknowledges receipt of its slave address by pulling SDA low during the 9th SCL clock pulse. A START command followed by a read command resets the address pointer to register 0x0. The first byte transmitted from the MAX9850 will be the contents of register 0x0. Transmitted data is valid on the rising edge of the master-generated serial clock (SCL). The address pointer autoincrements after each read data byte. This autoincrement feature allows all registers to be read sequentially within one continuous frame.

A STOP condition can be issued after any number of read data bytes. If a STOP condition is issued followed by another read operation, the first data byte to be read will be from register 0x0 and subsequent reads will autoincrement the address pointer until the next STOP condition.

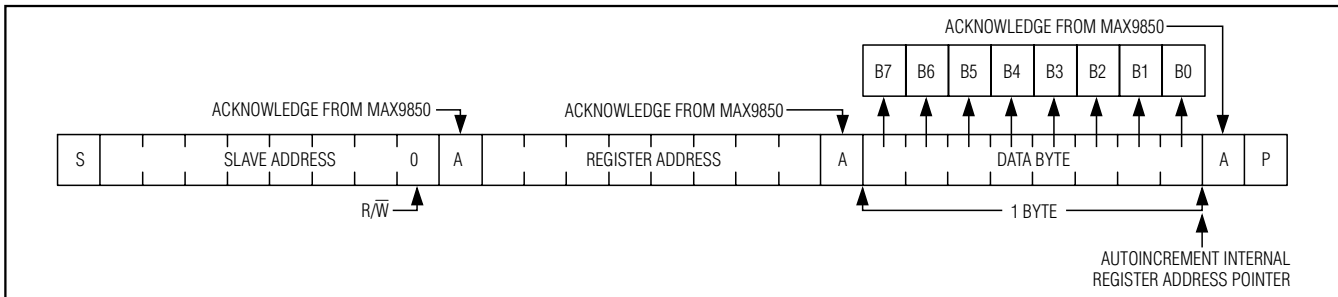

Figure 8. Writing One Byte of Data to the MAX9850

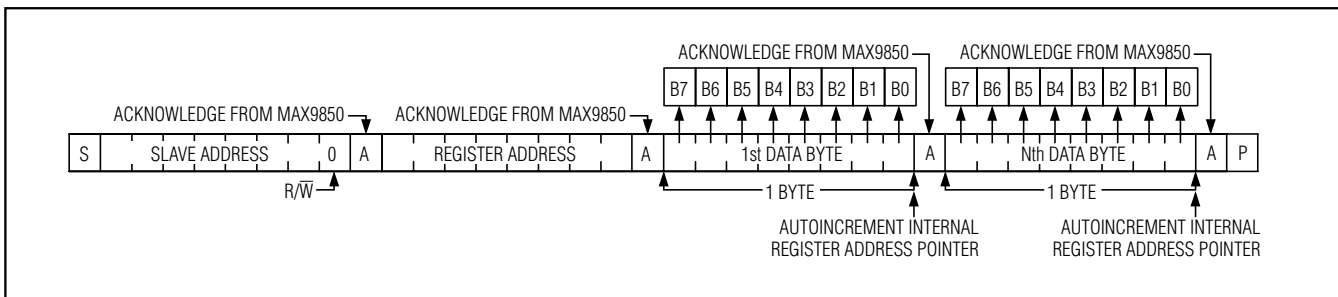

Figure 9. Writing n-Bytes of Data to the MAX9850

# Stereo Audio DAC with DirectDrive Headphone Amplifier

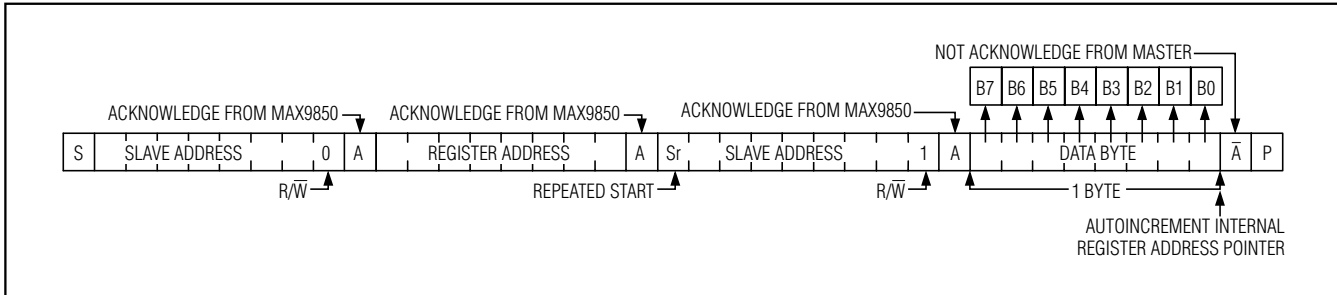

Figure 10. Reading One Byte of Data from MAX9850

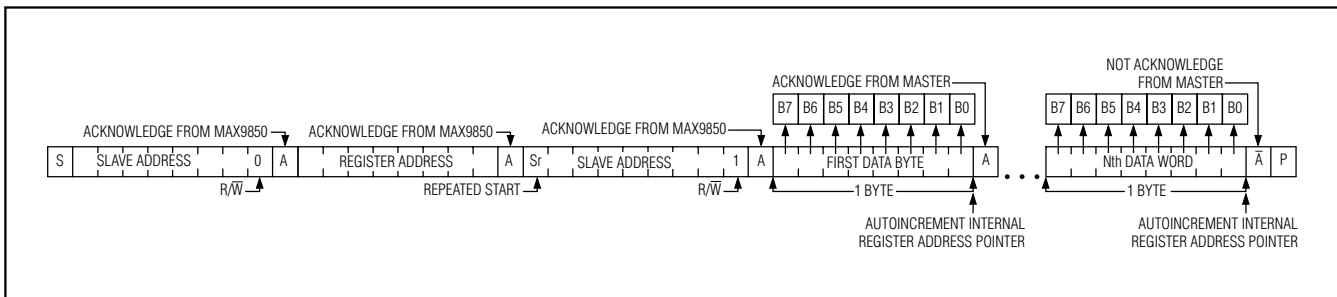

Figure 11. Reading n-Bytes from MAX9850

The address pointer can be preset to a specific register before a read command is issued. The master presets the address pointer by first sending the MAX9850's slave address with the R/W bit set to 0 followed by the register address. A REPEATED START condition is then sent followed by the slave address with the R/W bit set to 1. The MAX9850 transmits the contents of the specified register. The address pointer autoincrements after transmitting the first byte. Attempting to read from register addresses higher than 0xB results in repeated reads of 0xB. Note that 0xB is a reserved register.

The master acknowledges receipt of each read byte during the acknowledge clock pulse. The master must acknowledge all correctly received bytes except the last byte. The final byte must be followed by a not-acknowledge from the master and then a STOP condition. Figure 10 illustrates the frame format for reading one byte from the MAX9850. Figure 11 illustrates the frame format for reading multiple bytes from the MAX9850.

## Applications Information

### Powering On/Off the MAX9850

The MAX9850 powers on in low-power shutdown mode with the DAC, headphones, line inputs, and outputs all disabled. For useful circuit operation to be available, the charge pump needs to be activated using CPEN(1:0) in the enable register (register 0x5, bits B5

and B4). Setting the appropriate bits in the enable register will enable the desired circuit functions on the MAX9850. Finally, the global shutdown bit, SHDN needs to be set to 1 (register 0x5, bit B7). The enable bits can all be set with a single I<sup>2</sup>C write operation.

It is good practice for an application to configure the I<sup>2</sup>C registers before taking the MAX9850 out of shutdown. This may include setting initial volume levels, DAC mode of operation, stereo or mono operation, and audio interface settings. Powering on the MAX9850 with all the registers set ensures that the audio output will not be interrupted.

The charge pump starts and establishes the internal supply voltages once the appropriate byte is written to the enable register. The MAX9850 is ready for operation approximately 10ms after the charge pump is enabled. If selected, the headphone outputs will also complete a clickless/popless power-up sequence during this time. The headphone amplifier status bit (SHP) (register 0x1, bit B3) sets to 1 once the headphones are ready to operate. The line inputs and outputs will also turn on during this 10ms startup period if enabled.

Let AC-coupling capacitors settle before enabling the line input amplifiers. The input-coupling capacitor charges to the output bias voltage of the driving device even while the MAX9850 is in shutdown. The input AC coupling capacitors are charged and ready for use immediately after power is applied to the system in most applications.



# Stereo Audio DAC with DirectDrive Headphone Amplifier

**MAX9850**

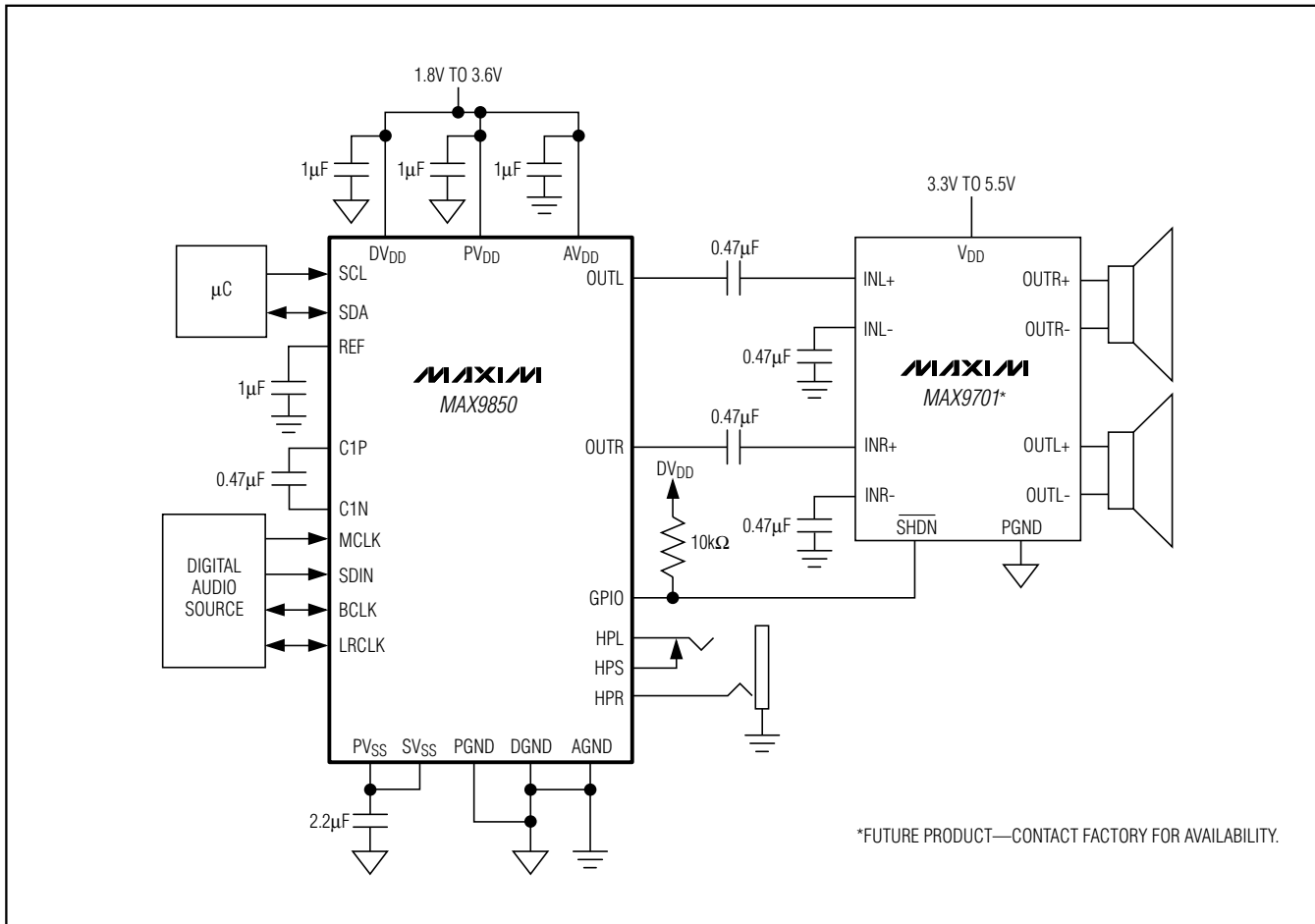

Figure 12. Stereo Speakerphone

The DAC begins its soft-start routine after being enabled and after receiving 32 LRCLK cycles. All internal filters are initialized and the DAC gain gradually ramps to maximum. The MAX9850's headphone output level is determined by the headphone amplifier volume setting.

Mute the audio outputs before powering down the MAX9850 by setting MUTE to 1 (register 0x2, bit B7). Ramping the volume to its maximum attenuation is an alternative to muting the output. VMN in the status A register (register 0x0, bit B3) notifies the µC when the outputs are at maximum attenuation. Disable the headphone and line outputs once the audio is fully attenuated. Headphone and line outputs can be disabled within 50µs without any audible clicks or pops, once the audio is fully attenuated. Place the MAX9850 in shut-down after the outputs are disabled.

## Stereo Speakerphone

The MAX9850 can be combined with a stereo speaker amplifier to create a complete speakerphone playback solution. The MAX9701, or another Maxim stereo speaker amplifier, can be used to drive the speakers while the MAX9850's integrated DirectDrive headphone amplifier drives the headphones (see Figure 12).

Configure GPIO to output high when a headphone is not connected and low when the headphone is connected. Connect GPIO to the SHDN control of the MAX9701. Configure the interrupt enable register to set ALERT (register 0x0, bit B7) when HPS changes state. The µC polls the status A register and waits for ALERT to set when HPS changes state. The µC changes the state of GPIO when ALERT is set, either turning off the speaker amp because a headphone is connected or enabling the speaker amp when the headphone is disconnected.

# Stereo Audio DAC with DirectDrive Headphone Amplifier

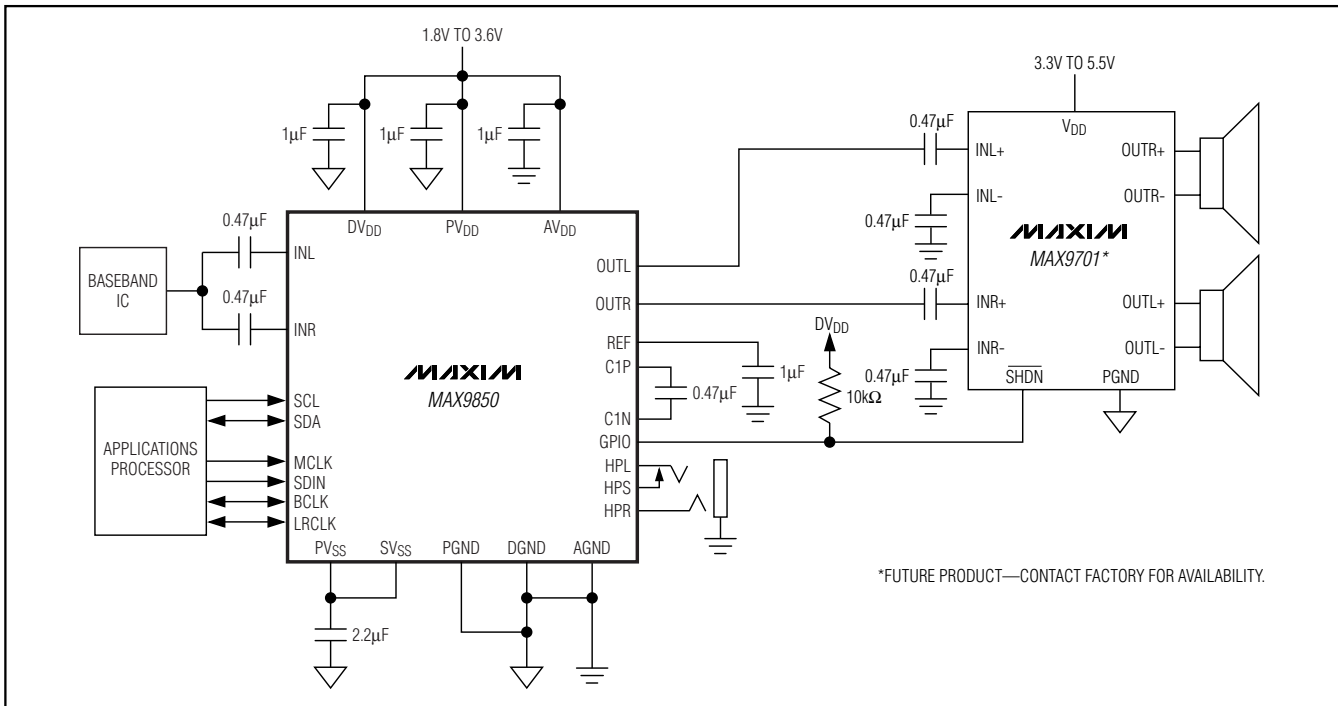

Figure 13. Cell Phone Audio

## Cell Phone Audio

The MAX9850 is a complete cell-phone audio playback solution. In a typical application, ringtones are created and output through the application's processor on the digital audio bus. Connect the baseband IC to the line inputs of the MAX9850, INR and INL. The headphone amplifier outputs a summed version of the digital audio input and the line input (see Figure 13).

## Headphone Short Circuit

The headphone amplifiers can provide almost  $\pm 300\text{mA}$  per channel during a short-circuit event. The MAX9850 has been designed to withstand this current continuously. To avoid unnecessarily draining a battery, it is advised to enable the IOHR and IOHL hardware interrupt. The  $\mu\text{C}$  can service the interrupt by disabling the headphone amplifiers and waiting for a timeout period.

A headphone short-circuit event on the right channel only may also indicate that a mono headphone has been inserted into the stereo socket. The  $\mu\text{C}$  can then automatically disable the right channel by placing the MAX9850 in mono mode. This resolves a mono jack-induced, short-circuit condition.

## PC Board Layout and Bypassing

Proper layout and grounding are essential for optimum performance. Use large traces for the power-supply inputs and amplifier outputs to minimize losses due to parasitic trace resistance. Large traces also aid in moving heat away from the package. Proper grounding improves audio performance, minimizes crosstalk between channels, and prevents any switching noise from coupling into the audio signal. Connect PGND, DGND, and AGND together at a single point on the PC board. Route DGND, PGND, and all traces that carry switching transients or digital signals away from AGND and traces or components in the analog audio-signal path.

Connect all components associated with the charge pump to PGND. Connect PVSS and SVSS together at the device. Place the charge-pump capacitors as close to PVSS as possible. Ensure C2 is connected to PGND. Bypass PVDD with  $1\mu\text{F}$  to PGND. Place the bypass capacitors as close to the device as possible.

The MAX9850 thin QFN package features an exposed thermal pad on its underside. This pad lowers the package's thermal resistance by providing a direct heat conduction path from the die to the printed circuit board. If possible, connect the exposed thermal pad to an electrically isolated, large pad of copper. If it cannot be left floating, connect it to AGND.

# Stereo Audio DAC with DirectDrive Headphone Amplifier

## Pin Configuration

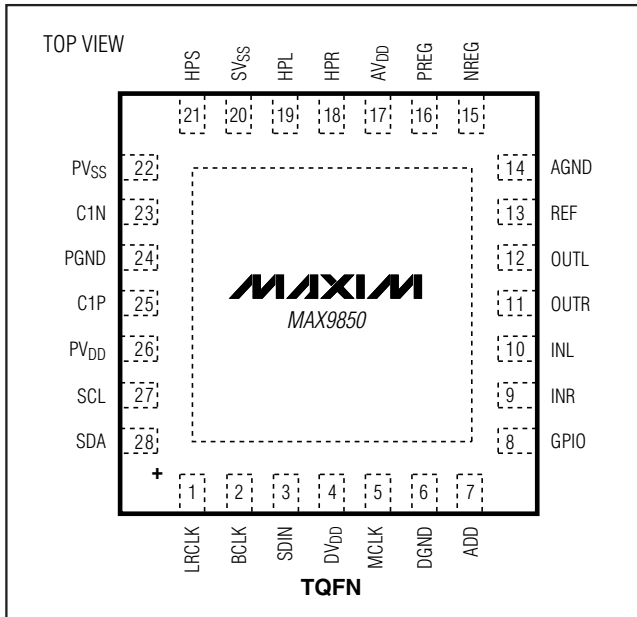

## Chip Information

TRANSISTOR COUNT: 104,069  
PROCESS: BICMOS

**MAX9850**

# Stereo Audio DAC with DirectDrive Headphone Amplifier

## Package Information

(The package drawing(s) in this data sheet may not reflect the most current specifications. For the latest package outline information, go to [www.maxim-ic.com/packages](http://www.maxim-ic.com/packages).)

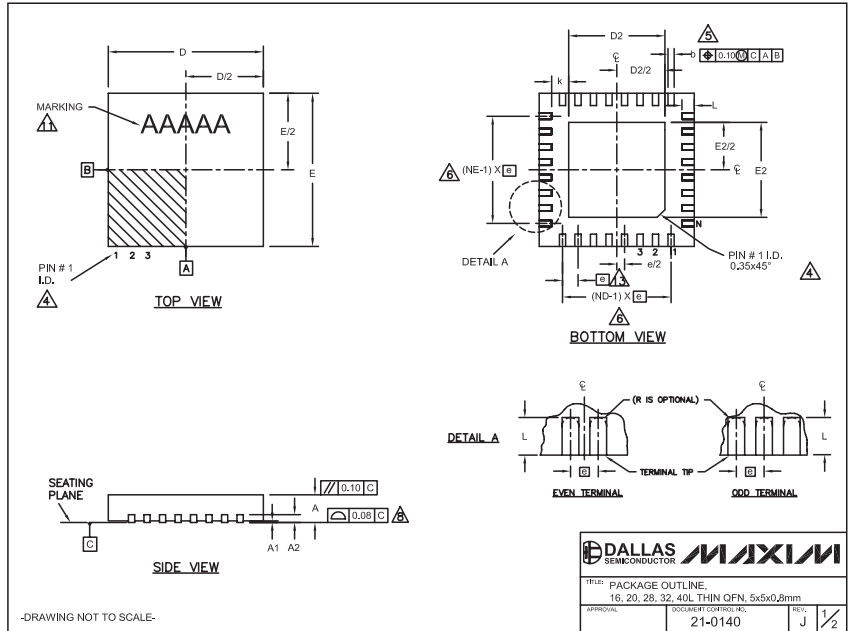

QFN THINLEDS

COMMON DIMENSIONS															
PKG.	16L 5x5			20L 5x5			28L 5x5			32L 5x5			40L 5x5		
SYMBOL	MIN.	NOM.	MAX.	MIN.	NOM.	MAX.	MIN.	NOM.	MAX.	MIN.	NOM.	MAX.	MIN.	NOM.	MAX.
A	0.70	0.75	0.80	0.70	0.75	0.80	0.70	0.75	0.80	0.70	0.75	0.80	0.70	0.75	0.80
A1	0	0.02	0.05	0	0.02	0.05	0	0.02	0.05	0	0.02	0.05	0	0.02	0.05
A2	0.20 REF.			0.20 REF.			0.20 REF.			0.20 REF.			0.20 REF.		
b	0.25	0.30	0.35	0.25	0.30	0.35	0.20	0.25	0.30	0.20	0.25	0.30	0.15	0.20	0.25
D	4.90	5.00	5.10	4.90	5.00	5.10	4.90	5.00	5.10	4.90	5.00	5.10	4.90	5.00	5.10
E	4.90	5.00	5.10	4.90	5.00	5.10	4.90	5.00	5.10	4.90	5.00	5.10	4.90	5.00	5.10
e	0.80 BSC.			0.65 BSC.			0.50 BSC.			0.50 BSC.			0.40 BSC.		
k	0.25	-	-	0.25	-	-	0.25	-	-	0.25	-	-	0.25	-	-
L	0.30	0.40	0.50	0.45	0.55	0.65	0.45	0.55	0.65	0.30	0.40	0.50	0.30	0.40	0.50
N	16			20			28			32			40		
ND	4			5			7			8			10		
NE	4			5			7			8			10		
JEDEC	WHHB			WHHC			WHHD-1			WHHD-2			---		

EXPOSED PAD VARIATIONS						
PKG. CODES	D2			E2		
	MIN.	NOM.	MAX.	MIN.	NOM.	MAX.
T1855-2	3.00	3.10	3.20	3.00	3.10	3.20
T1855-3	3.00	3.10	3.20	3.00	3.10	3.20
T1855N-1	3.00	3.10	3.20	3.00	3.10	3.20
T2055-3	3.00	3.10	3.20	3.00	3.10	3.20
T2055-4	3.00	3.10	3.20	3.00	3.10	3.20
T2055-5	3.15	3.25	3.35	3.15	3.25	3.35
T2855-3	3.15	3.25	3.35	3.15	3.25	3.35
T2855-4	2.60	2.70	2.80	2.60	2.70	2.80
T2855-5	2.60	2.70	2.80	2.60	2.70	2.80
T2855-6	3.15	3.25	3.35	3.15	3.25	3.35
T2855-7	2.60	2.70	2.80	2.60	2.70	2.80
T2855-8	3.15	3.25	3.35	3.15	3.25	3.35
T2855N-1	3.15	3.25	3.35	3.15	3.25	3.35
T3255-3	3.00	3.10	3.20	3.00	3.10	3.20
T3255-4	3.00	3.10	3.20	3.00	3.10	3.20
T3255-5	3.00	3.10	3.20	3.00	3.10	3.20
T3255N-1	3.00	3.10	3.20	3.00	3.10	3.20
T4055-1	3.40	3.50	3.60	3.40	3.50	3.60
T4055-2	3.40	3.50	3.60	3.40	3.50	3.60

\*\*\*SEE COMMON DIMENSIONS TABLE

NOTES:

- DIMENSIONING & TOLERANCING CONFORM TO ASME Y14.5M-1994.
- ALL DIMENSIONS ARE IN MILLIMETERS, ANGLES ARE IN DEGREES.
- N IS THE TOTAL NUMBER OF TERMINALS.
- THE TERMINAL #1 IDENTIFIER AND TERMINAL NUMBERING CONVENTION SHALL CONFORM TO JEDEC 95-1 SPP-012. DETAILS OF TERMINAL #1 IDENTIFIER ARE OPTIONAL, BUT MUST BE LOCATED WITHIN THE ZONE INDICATED. THE TERMINAL #1 IDENTIFIER MAY BE EITHER A MOLD OR MARKED FEATURE.
- DIMENSION b APPLIES TO METALLIZED TERMINAL AND IS MEASURED BETWEEN 0.25 mm AND 0.30 mm FROM TERMINAL TIP.
- ND AND NE REFER TO THE NUMBER OF TERMINALS ON EACH D AND E SIDE RESPECTIVELY.
- DEPOSITION IS POSSIBLE IN A SYMMETRICAL FASHION.
- COPLANARITY APPLIES TO THE EXPOSED HEAT SINK SLUG AS WELL AS THE TERMINALS.
- DRAWING CONFORMS TO JEDEC MO220, EXCEPT EXPOSED PAD DIMENSION FOR T2855-3 AND T2855-4.
- WARPAGE SHALL NOT EXCEED 0.10 mm.
- MARKING IS FOR PACKAGE ORIENTATION REFERENCE ONLY.
- NUMBER OF LEADS SHOWN ARE FOR REFERENCE ONLY.
- LEAD CENTERLINES TO BE AT TRUE POSITION AS DEFINED BY BASIC DIMENSION "e", ±0.05.

-DRAWING NOT TO SCALE-

Maxim cannot assume responsibility for use of any circuitry other than circuitry entirely embodied in a Maxim product. No circuit patent licenses are implied. Maxim reserves the right to change the circuitry and specifications without notice at any time.

36 **Maxim Integrated Products, 120 San Gabriel Drive, Sunnyvale, CA 94086 408-737-7600**